



Lighting your needs

PRODUCT CATALOGUE

— 2025

— WWW.DASTERI.GR



CONTENTS

— COMPANY	OUR PROFILE	05
— PRODUCTS	● WARNING LAMPS	11
	● MULTIFUNCTIONAL REAR LAMPS	35
	● FRONT POSITION LAMPS & DRL	73
	● DIRECTION INDICATOR LAMPS	85
	● REVERSING LAMPS	93
	● FOG LAMPS	99
	● STOP & CHMSL STOP LAMPS	103
	● WORK LAMPS & HEADLAMPS	107
	● NUMBER PLATE LAMPS	117
	● MARKER LAMPS	121
	● INTERIOR LAMPS	155
	● REFLEX REFLECTORS	165
	● WIRING KITS & VARIOUS PARTS	169





OUR PROFILE

DASTERI is an innovative Automotive Lighting manufacturer based in Greece, since 1976.



— Productivity and Innovation

By constantly investing in highly qualified staff and new technologies our company is today an established European company that exports its products to 48 countries and multiple distribution points around the world. Dasteri products are manufactured according to the specifications of the Quality Management System for Automotive Sector IATF 16949:2016, Quality Management System ISO 9001, Environmental Management System ISO 14001:2015 and Health & Safety Management System ISO: 45001:2018 to fully meet the requirements of European and international markets



— Growth and Development

Today, Dasteri possesses the necessary experience and expertise since it has completed a large variety of projects with utter success through open and international tenders. With a commitment to research and planning for innovative services and products, Dasteri continues to make large investments in terms of means and efforts to meet the market requirements in the best possible way.

Dasteri's success is the result of continuous research for quality at every stage of production. The company has a large number of professionals who have the know-how in design, production and marketing in order to service our customers.



— Vertically Integrated Production

Both NIK. DASTERIDIS SA (MFG) and DASTERI SYSTEMS SA, by investing in pioneer technology, have managed to address their customers needs in the best possible way. All the products are manufactured in two completely self-sufficient, privately-owned production facilities of 15.500 square metres:

- Research and development department where solutions for the ever changing market requirements, new ideas, materials, design and construction techniques are developed.
- Study and design department that provides solutions to customer needs.
- Fully equipped moulding department with software and cutting-edge generation CNC machines.
- Expert production and assembly units equipped with new generation machines and staffed with the most qualified and trained personnel.
- Quality control department where tests are performed in order to ensure that our products fully meet the European and international standards.
- Customer service which aims to resolve problems and to satisfy the needs of our customers.







OUR PRINCIPLES

Our position as a leading company opens up unique opportunities for us to contribute to a sustainable future.



— High Quality Service

Fostered by reliable cooperation with our customers, our unremitting service to their needs aims not just to solve problems but to thoroughly meet their contemporary demands, too.

Our professionalism combined with friendly and prompt service are the principles that best describe our identity and designate our relationship with all our partners and customers; principles that define every contact we make with them.



— Responsibility and Reliability

Our main concern is the consistency with which we treat every customer, but also the environment in general. With respect and sincerity we commit to our promises in terms of delivery and outcome, thereby nurturing personal relationships of mutual trust with our customers.

Respect for the environment and its protection, as well as contribution to social issues, are matters integrated into our operating principles and philosophy. For this reason, our production processes are environmentally friendly and undertaken with full awareness to ensure ecological protection standards.

— Corporate Quality



The success of NIK. DASTERIDIS SA (MFG) and DASTERI SYSTEMS SA is the result of a continuous research for quality in every step of the productive process. All NIK. DASTERIDIS SA (MFG) and DASTERI SYSTEMS SA products consist of the most excellent quality according to the requirements of ISO 9001:2015, IATF 16949:2016, ISO 45001:2018 and ISO 14001:2015 Quality Management Systems and the international models and correspond completely to the requirements of the international market

The attentive selection of the materials, the adaptation of effective methods and the strict inspection of the productive circle, constitute the quality guarantee of all Dasteri products.

— Customer-Centered Philosophy

The continuous service of the customer's needs and the professional cooperation, aims to provide solutions to their problems and to meet with the best possible way their contemporary demands. The high quality services that NIK. DASTERIDIS SA (MFG) and DASTERI SYSTEMS SA provide to their customers, confirm the choice and satisfy their requirements and expectations.

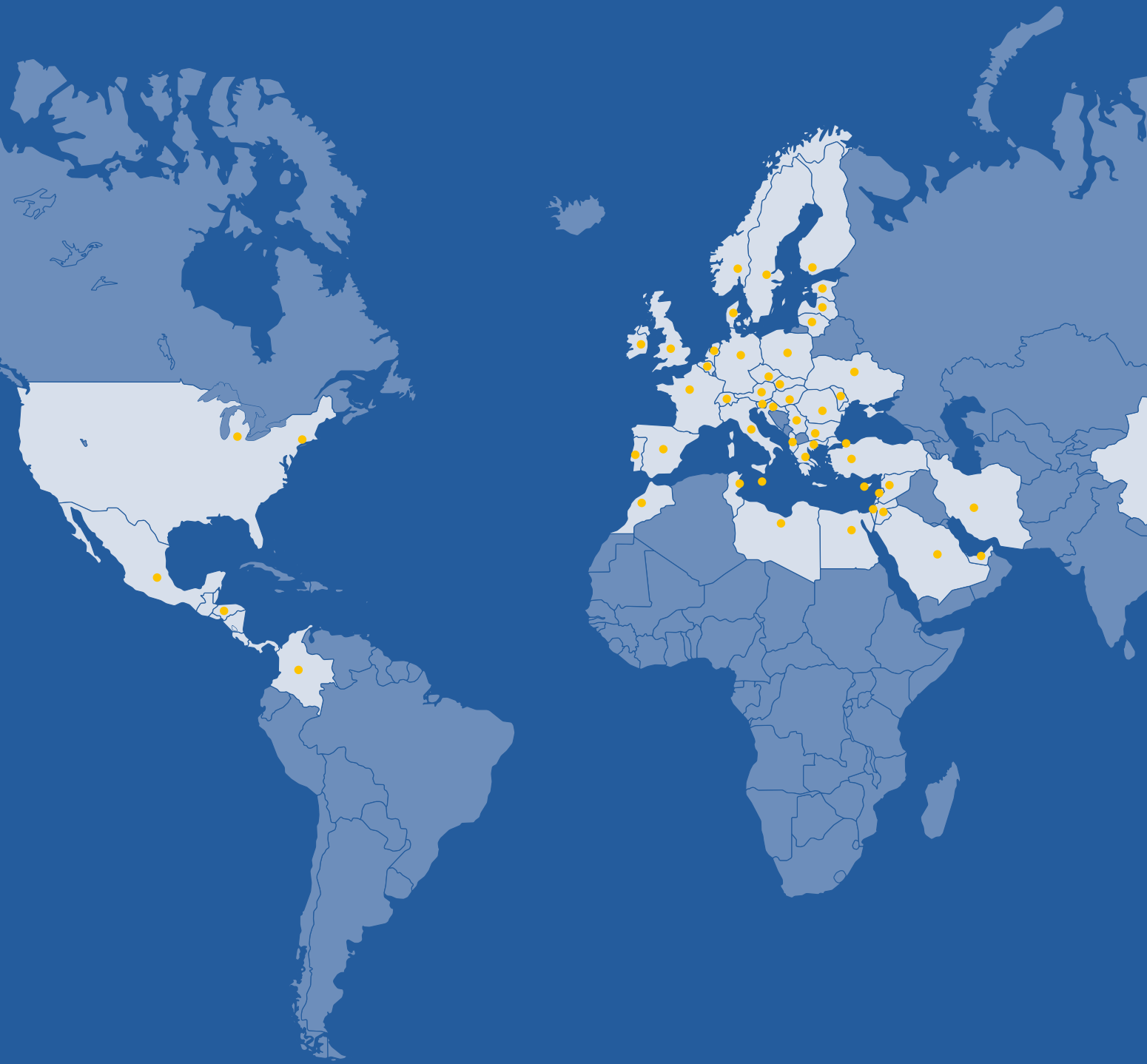



GLOBAL PRESENCE

Dasteri is present in key markets all around the world, with multiple distribution points.



- | | | |
|----------------|---------------|--------------|
| ALBANIA | IRELAND | ROMANIA |
| AUSTRIA | ISRAEL | SAUDI ARABIA |
| BELGIUM | ITALY | SERBIA |
| BULGARIA | JORDAN | SINGAPORE |
| CHECH REPUBLIC | LATVIA | SLOVAKIA |
| CHINA | LEBANON | SLOVENIA |
| COLOMBIA | LIBYA | SPAIN |
| CYPRUS | LITHUANIA | SWEDEN |
| DENMARK | MALTA | SWITZERLAND |
| EGYPT | MEXICO | SYRIA |
| ESTHONIA | MOROCCO | TURKEY |
| FINLAND | MOLDOVA | TUNISIA |
| FRANCE | NETHERLANDS | UAE |
| GERMANY | NEW CALEDONIA | UK |
| GREECE | NORWAY | USA |
| HUNGARY | POLAND | |
| IRAN | PORTUGAL | |



WARNING LAMPS





LED FLASHING BEACON / DSL-450 SERIES

TECHNICAL SPECIFICATIONS

Operating Voltage:	10-30V DC
Operating Temperature:	-40 °C to +65 °C
Consumption:	From 14 to 28W (depends on the flashing frequency)
Reverse polarity protection:	Yes
Flashing Frequency:	10 Flashing Patterns
Flash rate:	150 fpm (single flash)
Type of Protection:	IP67
Lens:	Polycarbonate

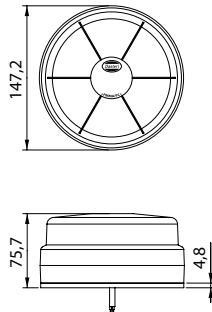

WITH FLAT BASE

REF. No	
DSL-450.05	Clear lens, Amber LEDs
DSL-450.06	Clear lens, Red LEDs
DSL-450.08	Clear lens, Blue LEDs

ECE APPROVED EMC APPROVED

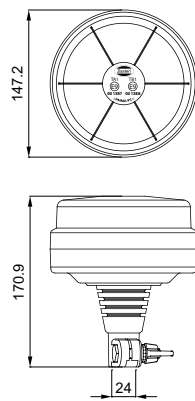

WITH FLEXIBLE BASE

REF. No	
DSL-450FL.05	Clear lens, Amber LEDs
DSL-450FL.06	Clear lens, Red LEDs
DSL-450FL.08	Clear lens, Blue LEDs

ECE APPROVED EMC APPROVED

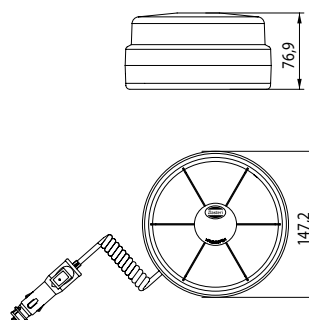

WITH MAGNETIC BASE

REF. No	
DSL-450M.05	Clear lens, Amber LEDs
DSL-450M.06	Clear lens, Red LEDs
DSL-450M.08	Clear lens, Blue LEDs

SPARE LENS

REF. No	
DSL-P-450.07	Spare lens, Clear

ECE APPROVED EMC APPROVED

LED BEACON / DSL-470 SERIES

TECHNICAL SPECIFICATIONS

Operating Voltage:	10-30V DC
Operating Temperature:	-40 °C to +65 °C
Consumption:	From 7.5W to 11W (depends on the flashing frequency)
Reverse polarity protection:	Yes
Flashing Frequency:	4 Flashing Patterns
Flash rate:	128 fpm (single flash)
Type of Protection:	IP67
Lens:	Polycarbonate

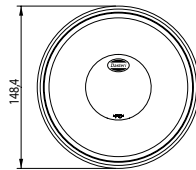

WITH FLAT BASE

REF. No	
DSL-470.05	Amber lens
DSL-470.06	Red lens
DSL-470.08	Clear lens, blue LEDs

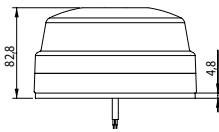

ECE APPROVED EMC APPROVED

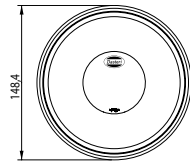

WITH FLEXIBLE BASE

REF. No	
DSL-470FL.05	Amber lens
DSL-470FL.06	Red lens
DSL-470FL.08	Clear lens, blue LEDs

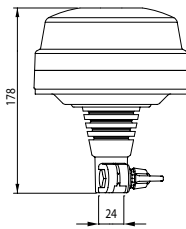

ECE APPROVED EMC APPROVED

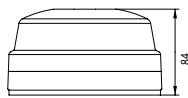

WITH MAGNETIC BASE

REF. No	
DSL-470M.05	Amber lens
DSL-470M.06	Red lens
DSL-470M.08	Clear lens, blue LEDs

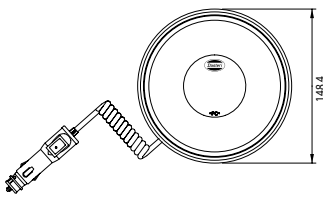

SPARE LENS

REF. No	
DSL-P-470.05	Spare lens, Amber
DSL-P-470.06	Spare lens, Red
DSL-P-470.07	Spare lens, Clear, for blue version beacon

ECE APPROVED EMC APPROVED

LED BEACON / DSL-480 SERIES

TECHNICAL SPECIFICATIONS

Operating Voltage:	10-30V DC
Operating Temperature:	-40 °C to +65 °C
Consumption:	From 26W to 42W (depends on the flashing frequency)
Reverse polarity protection:	Yes
Flashing Frequency:	10 Flashing Patterns
Type of Protection:	IP67
Lens:	Polycarbonate



ECE APPROVED

EMC APPROVED

WITH FLAT BASE

REF. No

DSL-480.05	Amber Lens
DSL-480.06	Red Lens
DSL-480.08	Clear Lens with Blue LEDs

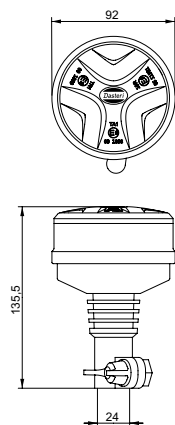

ECE APPROVED

EMC APPROVED

WITH FLEXIBLE BASE

REF. No

DSL-480FL.05	Amber Lens
DSL-480FL.06	Red Lens
DSL-480FL.08	Clear Lens with Blue LEDs



ECE APPROVED

EMC APPROVED

WITH MAGNETIC BASE

REF. No

DSL-480M.05	Amber Lens
DSL-480M.06	Red Lens
DSL-480M.08	Clear Lens with Blue LEDs

LED BEACON / DSL-490 SERIES

TECHNICAL SPECIFICATIONS

Operating Voltage:	10-30V DC
Operating Temperature:	-40 °C to +65 °C
Consumption:	From 7.5W to 11W (depends on the flashing frequency)
Reverse polarity protection:	Yes
Flashing Frequency:	4 Flashing Patterns
Flash rate:	128 fpm (single flash)
Type of Protection:	IP67
Housing:	Aluminum
Lens:	Polycarbonate



ECE APPROVED EMC APPROVED

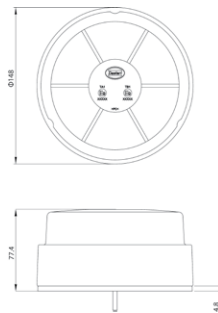

WITH FLAT BASE

REF. No	
DSL-490.05	Amber lens
DSL-490.06	Red lens
DSL-490.08	Clear lens, Blue LEDs



ECE APPROVED EMC APPROVED

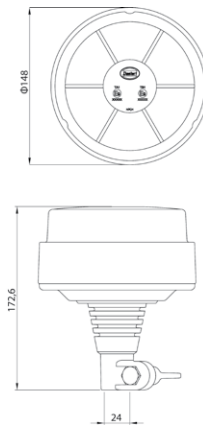

WITH FLEXIBLE BASE

REF. No	
DSL-490FL.05	Amber lens
DSL-490FL.06	Red lens
DSL-490FL.08	Clear lens, Blue LEDs



ECE APPROVED EMC APPROVED

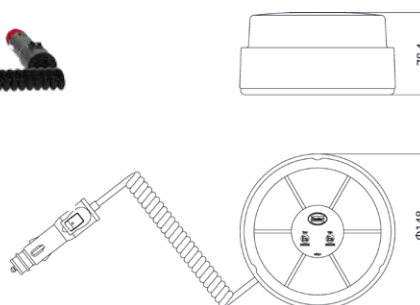

WITH MAGNETIC BASE

REF. No	
DSL-490M.05	Amber lens
DSL-490M.06	Red lens
DSL-490M.08	Clear lens, Blue LEDs

LED BEACON / DSL-495 SERIES

TECHNICAL SPECIFICATIONS

Operating Voltage:	10-30V DC
Operating Temperature:	-40 °C to +65 °C
Consumption:	From 7.5W to 11W (depends on the flashing frequency)
Reverse polarity protection:	Yes
Flashing Frequency:	4 Flashing Patterns
Flash rate:	128 fpm (single flash)
Type of Protection:	IP67
Lens:	Polycarbonate



ECE APPROVED

EMC APPROVED

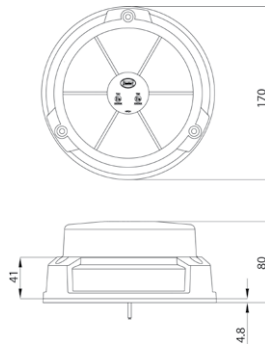

WITH FLAT BASE

REF. No

DSL-495.05	Amber lens
DSL-495.06	Red lens
DSL-495.08	Clear lens, Blue LEDs



ECE APPROVED

EMC APPROVED

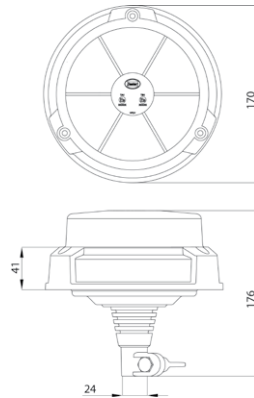

WITH FLEXIBLE BASE

REF. No

DSL-495FL.05	Amber lens
DSL-495FL.06	Red lens
DSL-495FL.08	Clear lens, Blue LEDs



ECE APPROVED

EMC APPROVED

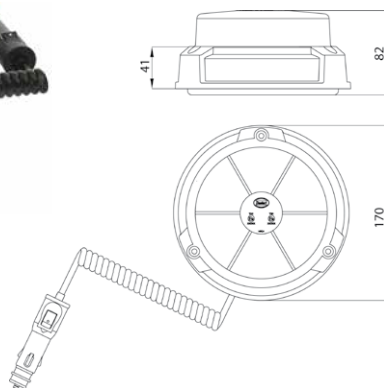

WITH MAGNETIC BASE

REF. No

DSL-495M.05	Amber lens
DSL-495M.06	Red lens
DSL-495M.08	Clear lens, Blue LEDs

NEW LED BEACON LAMP / DSL-W500L SERIES



TECHNICAL SPECIFICATIONS

Operating Voltage: 10-30V DC
Operating Temperature: -40 °C to +65 °C
Consumption: Amber: 27W, Red: 16W, Blue: 23W
Reverse polarity protection: Yes
Flashing Frequency: 10 Flashing Patterns
Flash rate: 125 fpm (single flash)
Mounting Way: Screw Mounting
Type of Protection: IP67

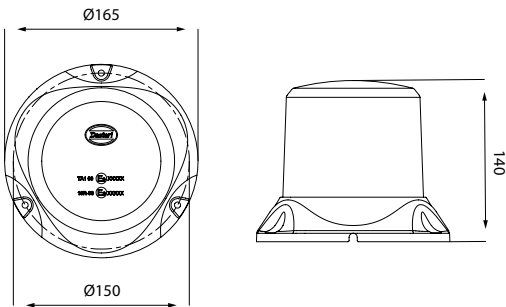

REF. No	Amber	Red	Blue
DSL-W500L.05	●		
DSL-W500L.06		●	
DSL-W500L.08			●



ECE APPROVED EMC APPROVED

NEW LED BEACON LAMP / DSL-W500LM SERIES



TECHNICAL SPECIFICATIONS

Operating Voltage: 10-30V DC
Operating Temperature: -40 °C to +65 °C
Consumption: Amber: 27W, Red: 16W, Blue: 23W
Reverse polarity protection: Yes
Flashing Frequency: 10 Flashing Patterns
Flash rate: 125 fpm (single flash)
Mounting Way: Magnetic Mounting
Type of Protection: IP67

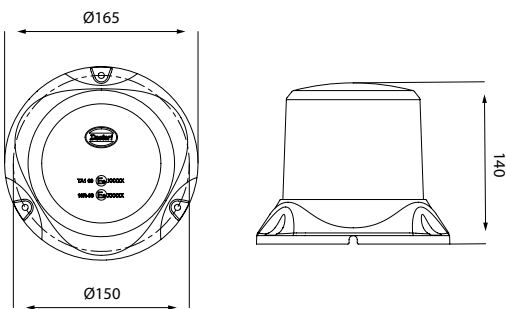

REF. No	Amber	Red	Blue
DSL-W500LM.05	●		
DSL-W500LM.06		●	
DSL-W500LM.08			●



ECE APPROVED EMC APPROVED

NEW LED BEACON LAMP / DSL-W500S SERIES



TECHNICAL SPECIFICATIONS

Operating Voltage: 10-30V DC
Operating Temperature: -40 °C to +65 °C
Consumption: Amber: 27W, Red: 16W, Blue: 23W
Reverse polarity protection: Yes
Flashing Frequency: 10 Flashing Patterns
Flash rate: 125 fpm (single flash)
Mounting Way: Screw Mounting
Type of Protection: IP67

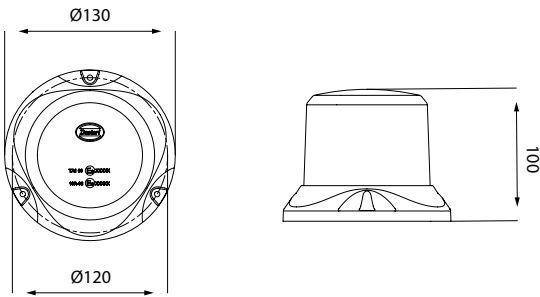

REF. No	Amber	Red	Blue
DSL-W500S.05	•		
DSL-W500S.06		•	
DSL-W500S.08			•



ECE APPROVED EMC APPROVED

NEW LED BEACON LAMP / DSL-W500SM SERIES



TECHNICAL SPECIFICATIONS

Operating Voltage: 10-30V DC
Operating Temperature: -40 °C to +65 °C
Consumption: Amber: 27W, Red: 16W, Blue: 23W
Reverse polarity protection: Yes
Flashing Frequency: 10 Flashing Patterns
Flash rate: 125 fpm (single flash)
Mounting Way: Magnetic Mounting
Type of Protection: IP67

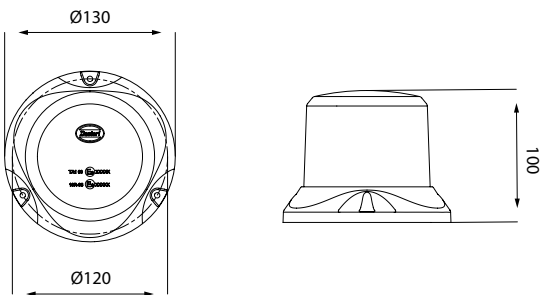

REF. No	Amber	Red	Blue
DSL-W500SM.05	•		
DSL-W500SM.06		•	
DSL-W500SM.08			•



ECE APPROVED EMC APPROVED

LED BEACON / DLL & DLS SERIES

TECHNICAL SPECIFICATIONS

Operating Voltage:	10-30V DC
Flash rate:	75 fpm
Flash type:	Triple flash
Operating Temperature:	-25 °C to +65 °C
Consumption:	12W
Reverse polarity protection:	Yes
Load Dump:	Protected
Sync:	Can be synchronized up to 16 beacons
Type of Protection:	IP67

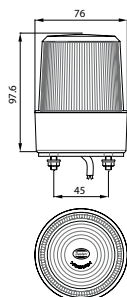

FLAT BASE / LONG DOME

REF. No	
DLL-S1M.05	Amber lens
DLL-S1M.06	Red lens
DLL-S1M.08	Blue lens
DLL-S1M.09	Green lens

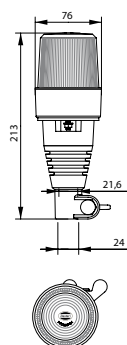

FLEXIBLE BASE / LONG DOME

REF. No	
DLL-SFL.05	Amber lens
DLL-SFL.06	Red lens
DLL-SFL.08	Blue lens
DLL-SFL.09	Green lens

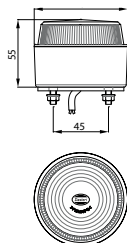

FLAT BASE / SHORT DOME

REF. No	
DLS-S1M.05	Amber lens
DLS-S1M.06	Red lens
DLS-S1M.08	Blue lens
DLS-S1M.09	Green lens

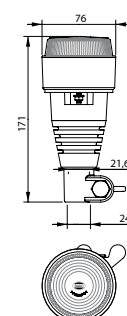

FLEXIBLE BASE / SHORT DOME

REF. No	
DLS-SFL.05	Amber lens
DLS-SFL.06	Red lens
DLS-SFL.08	Blue lens
DLS-SFL.09	Green lens

XENON BEACON / 440 SERIES

TECHNICAL SPECIFICATIONS

Operating Voltage: 10-36V DC
Flash rate: 126 fpm (single flash)
Flash type: Single / Double
Consumption: 22W
Type of Protection: IP54

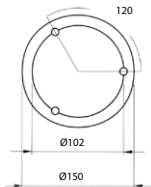
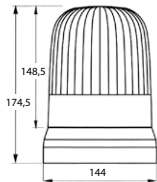

WITH FLAT BASE

REF. No

440/DV430.05 Amber lens
440/DV430.06 Red lens
440/DV430.08 Blue lens

MAGNETIC BASE

REF. No

440M/DV430.05 Amber lens
440M/DV430.06 Red lens
440M/DV430.08 Blue lens

FASTENING ON TUBE

REF. No

441/DV430.05 Amber lens
441/DV430.06 Red lens
441/DV430.08 Blue lens

SPARE LENS

REF. No

P-430.05 Spare lens, Amber
P-430.06 Spare lens, Red
P-430.08 Spare lens, Blue

ECE APPROVED

EMC APPROVED

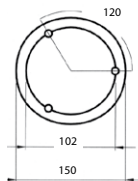
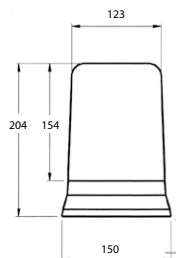

WITH FLAT BASE

REF. No

440/DV410.05 Amber lens
440/DV410.06 Red lens
440/DV410.08 Blue lens

MAGNETIC BASE

REF. No

440M/DV410.05 Amber lens
440M/DV410.06 Red lens
440M/DV410.08 Blue lens

FASTENING ON TUBE

REF. No

441/DV410.05 Amber lens
441/DV410.06 Red lens
441/DV410.08 Blue lens

SPARE LENS

REF. No

P-410.05 Spare lens, Amber
P-410.06 Spare lens, Red
P-410.08 Spare lens, Blue

ECE APPROVED

EMC APPROVED

ROTATING BEACON / 410 SERIES

TECHNICAL SPECIFICATIONS

Operating Voltage: 12 or 24V DC
Consumption: 12V 55W (H3) / 24V 70W (H3)
Flash rate: 210 fpm
Type of Protection: IP54

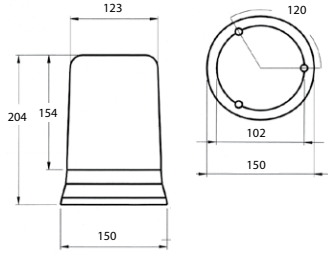

WITH FLAT BASE

- REF. No
410/12.05 Amber lens - 12V
410/12.06 Red lens - 12V
410/12.08 Blue lens - 12V
- REF. No
410/24.05 Amber lens - 24V
410/24.06 Red lens - 24V
410/24.08 Blue lens - 24V

ECE APPROVED

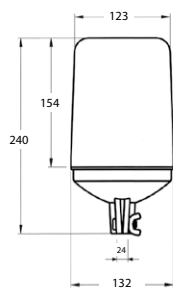

WITH FLEXIBLE BASE

- REF. No
411/12.05 Amber lens - 12V
411/12.06 Red lens - 12V
411/12.08 Blue lens - 12V
- REF. No
411/24.05 Amber lens - 24V
411/24.06 Red lens - 24V
411/24.08 Blue lens - 24V

ECE APPROVED

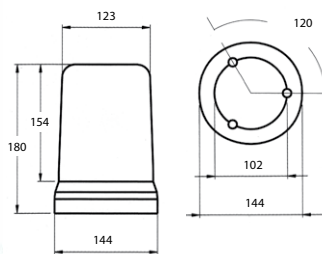

WITH MAGNETIC BASE

- REF. No
410M/12.05 Amber lens - 12V
410M/12.06 Red lens - 12V
410M/12.08 Blue lens - 12V
- REF. No
410M/24.05 Amber lens - 24V
410M/24.06 Red lens - 24V
410M/24.08 Blue lens - 24V

ECE APPROVED

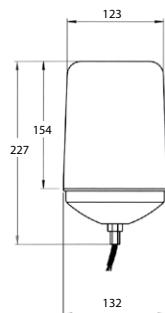

WITH SINGLE BOLT M12

- REF. No
412/12.05 Amber lens - 12V
412/12.06 Red lens - 12V
412/12.08 Blue lens - 12V
- REF. No
412/24.05 Amber lens - 24V
412/24.06 Red lens - 24V
412/24.08 Blue lens - 24V

SPARE LENS

- REF. No
P-410.05 Amber
P-410.06 Red
P-410.08 Blue

ECE APPROVED

ROTATING BEACON / 430 SERIES

TECHNICAL SPECIFICATIONS

Operating Voltage: 12 or 24V DC
Consumption: 12V 55W (H3) / 24V 70W (H3)
Flash rate: 210 fpm
Type of Protection: IP54

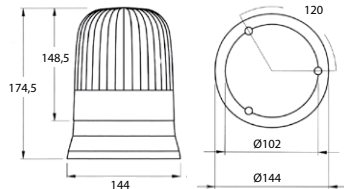

WITH FLAT BASE

- REF. No
430/12.05 Amber lens - 12V
430/12.06 Red lens - 12V
430/12.08 Blue lens - 12V
- REF. No
430/24.05 Amber lens - 24V
430/24.06 Red lens - 24V
430/24.08 Blue lens - 24V

ECE APPROVED

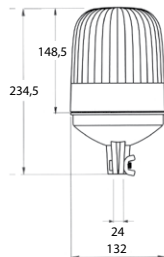

WITH FLEXIBLE BASE

- REF. No
431/12.05 Amber lens - 12V
431/12.06 Red lens - 12V
431/12.08 Blue lens - 12V
- REF. No
431/24.05 Amber lens - 24V
431/24.06 Red lens - 24V
431/24.08 Blue lens - 24V

ECE APPROVED

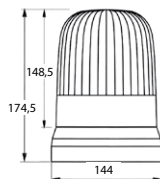

WITH MAGNETIC BASE

- REF. No
430M/12.05 Amber lens - 12V
430M/12.06 Red lens - 12V
430M/12.08 Blue lens - 12V
- REF. No
430M/24.05 Amber lens - 24V
430M/24.06 Red lens - 24V
430M/24.08 Blue lens - 24V

ECE APPROVED

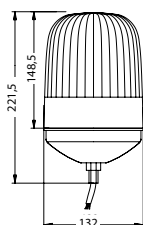

WITH SINGLE BOLT M12

- REF. No
432/12.05 Amber lens - 12V
432/12.06 Red lens - 12V
432/12.08 Blue lens - 12V
- REF. No
432/24.05 Amber lens - 24V
432/24.06 Red lens - 24V
432/24.08 Blue lens - 24V

SPARE LENS

- REF. No
P-430.05 Amber
P-430.06 Red
P-430.08 Blue

ECE APPROVED

ROTATING BEACON / 460 SERIES

TECHNICAL SPECIFICATIONS

Operating Voltage: 9-33V DC
Consumption: 12V 55W (H1) / 24V 70W (H1)
Flash rate: 210 fpm
Type of Protection: IP54



ECE APPROVED

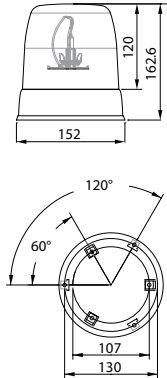

WITH FLAT BASE

REF. No

- 460/12-24.05** Amber lens
- 460/12-24.06** Red lens
- 460/12-24.08** Blue lens
- 460/12-24.09** Green lens



ECE APPROVED

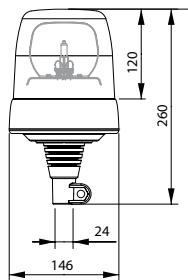

WITH FLEXIBLE BASE

REF. No

- 461/12-24.05** Amber lens
- 461/12-24.06** Red lens
- 461/12-24.08** Blue lens
- 461/12-24.09** Green lens



ECE APPROVED

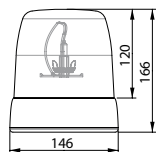

WITH MAGNETIC BASE

REF. No

- 460M/12-24.05** Amber lens
- 460M/12-24.06** Red lens
- 460M/12-24.08** Blue lens
- 460M/12-24.09** Green lens

SPARE LENS

REF. No

- P-460.05** Spare lens, amber
- P-460.06** Spare lens, red
- P-460.08** Spare lens, blue
- P-460.09** Spare lens, green

ROTATING BEACON / 420 SERIES DUAL VOLTAGE

TECHNICAL SPECIFICATIONS

Operating Voltage: 9-33V DC
Consumption: 12V 55W (H1) / 24V 70W (H1)
Flash rate: 210 fpm
Type of Protection: IP54

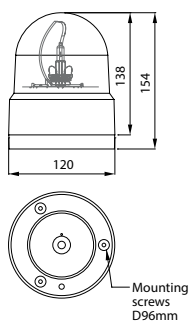

WITH FLAT BASE

REF. No
420/12-24.05 Amber lens
420/12-24.06 Red lens
420/12-24.08 Blue lens
420/12-24.09 Green lens

ECE APPROVED

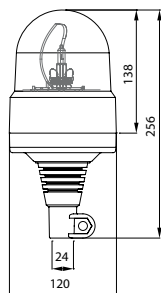

WITH FLEXIBLE BASE

REF. No
421/12-24.05 Amber lens
421/12-24.06 Red lens
421/12-24.08 Blue lens
421/12-24.09 Green lens

ECE APPROVED

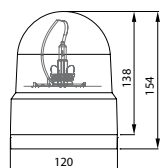

WITH MAGNETIC BASE

REF. No
420M/12-24.05 Amber lens
420M/12-24.06 Red lens
420M/12-24.08 Blue lens
420M/12-24.09 Green lens

ECE APPROVED

SPARE LENS

REF. No
P-420.05 Spare lens, Amber
P-420.06 Spare lens, Red
P-420.08 Spare lens, Blue
P-420.09 Spare lens, Green

ROTATING BEACON / 420 SERIES

TECHNICAL SPECIFICATIONS

Operating Voltage: 12 or 24V DC
Consumption: 12V 21W / 24V 21W (BA15S)
Flash rate: 210 fpm
Type of Protection: IP54

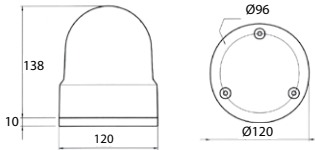

WITH FLAT BASE

REF. No		REF. No	
420/12.05	Amber lens - 12V	420/24.05	Amber lens - 24V
420/12.06	Red lens - 12V	420/24.06	Red lens - 24V
420/12.08	Blue lens - 12V	420/24.08	Blue lens - 24V
420/12.09	Green lens - 12V	420/24.09	Green lens - 24V

ECE APPROVED

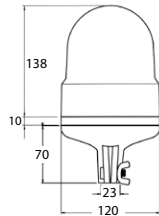

FASTENING ON TUBE

REF. No		REF. No	
421FL/12.05	Amber lens - 12V	421/24.05	Amber lens - 24V
421FL/12.06	Red lens - 12V	421/24.06	Red lens - 24V
421FL/12.08	Blue lens - 12V	421/24.08	Blue lens - 24V
421FL/12.09	Green lens - 12V	421/24.09	Green lens - 24V

ECE APPROVED

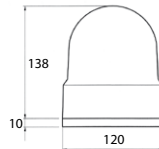

WITH MAGNETIC BASE

REF. No	
420M/12.05	Amber lens - 12V
420M/12.06	Red lens - 12V
420M/12.08	Blue lens - 12V
420M/12.09	Green lens - 12V

SPARE LENS

REF. No	
P-420.05	Amber
P-420.06	Red
P-420.08	Blue
P-420.09	Green

REF. No	
420M/24.05	Amber lens - 24V
420M/24.06	Red lens - 24V
420M/24.08	Blue lens - 24V
420M/24.09	Green lens - 24V

ECE APPROVED

ROTATING BEACON / 400 SERIES

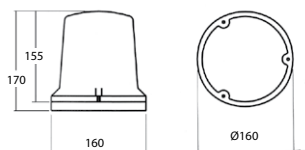

REF. No		REF. No	
400/12.05	Amber lens - 12V	400/24.05	Amber lens - 24V
400/12.06	Red lens - 12V	400/24.06	Red lens - 24V
400/12.08	Blue lens - 12V	400/24.08	Blue lens - 24V

SPARE LENS

REF. No	
P-400.05	Amber
P-400.06	Red
P-400.08	Blue

TECHNICAL SPECIFICATIONS

Operating Voltage: 12 or 24V DC
Consumption: 12V 55W / 24V 70W
Flash rate: 210 fpm
Type of Protection: IP54

ECE APPROVED

ROTATING BEACON / 425 SERIES

TECHNICAL SPECIFICATIONS

Operating Voltage: 12 or 24V DC
Consumption: 12V 21W / 24V 21W (BA15S)
Flash rate: 210 fpm
Type of Protection: IP54

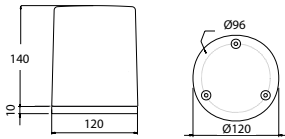

WITH FLAT BASE

REF. No		REF. No	
425/12.05	Amber lens - 12V	425/24.05	Amber lens - 24V
425/12.06	Red lens - 12V	425/24.06	Red lens - 24V
425/12.08	Blue lens - 12V	425/24.08	Blue lens - 24V
425/12.09	Green lens - 12V	425/24.09	Green lens - 24V

ECE APPROVED

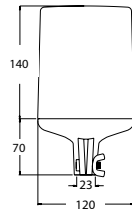

FASTENING ON TUBE

REF. No		REF. No	
426/12.05	Amber lens - 12V	426/24.05	Amber lens - 24V
426/12.06	Red lens - 12V	426/24.06	Red lens - 24V
426/12.08	Blue lens - 12V	426/24.08	Blue lens - 24V
426/12.09	Green lens - 12V	426/24.09	Green lens - 24V

ECE APPROVED

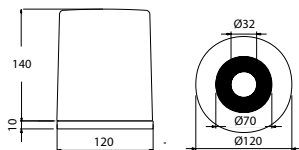

WITH MAGNETIC BASE

REF. No		REF. No	
425M/12.05	Amber lens - 12V	425M/24.05	Amber lens - 24V
425M/12.06	Red lens - 12V	425M/24.06	Red lens - 24V
425M/12.08	Blue lens - 12V	425M/24.08	Blue lens - 24V
425M/12.09	Green lens - 12V	425M/24.09	Green lens - 24V

ECE APPROVED

SPARE LENS

REF. No
P-425.05 Amber **P-425.06** Red **P-425.08** Blue **P-425.09** Green

LED LIGHT BAR / LB-500 SERIES

TECHNICAL SPECIFICATIONS

- Operating Voltage:** 10-30V DC
- Consumption:** From 40W to 56W (according to color/flashing frequency)
- Reverse polarity protection:** Yes
- Flashing Frequency:** 10 Flashing Patterns
- Type of Protection:** IP67

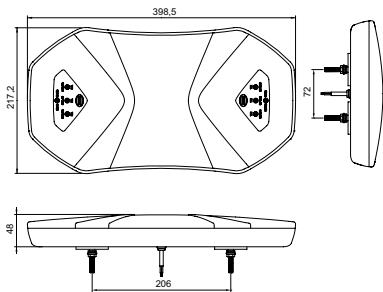

ECE APPROVED

EMC APPROVED

WITH FLAT BASE

REF. No

- LB-500.05** Clear lens, Amber LEDs
- LB-500.06** Clear lens, Red LEDs
- LB-500.08** Clear lens, Blue LEDs

WITH MAGNETIC BASE

REF. No

- LB-500M.05** Clear lens, Amber LEDs
- LB-500M.06** Clear lens, Red LEDs
- LB-500M.08** Clear lens, Blue LEDs

LED LIGHT BAR / LB-600 SERIES

TECHNICAL SPECIFICATIONS

- Operating Voltage:** 10-30V DC
- Consumption:** From 27W to 109W (according to modules/color/flashing frequency)
- Reverse polarity protection:** Yes
- Flashing Frequency:** 10 Flashing Patterns
- Type of Protection:** IP67

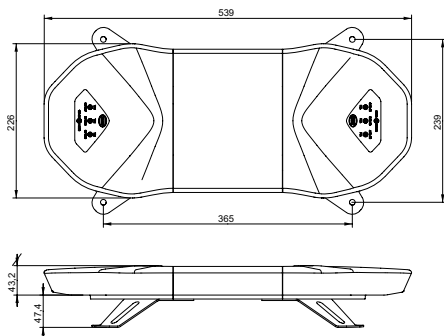

ECE APPROVED

EMC APPROVED

REF. No

- LB-6XX.05** Clear lens, Amber LEDs
- LB-6XX.06** Clear lens, Red LEDs
- LB-6XX.08** Clear lens, Blue LEDs

Where XX add number of LED modules (from 01 to 12)
 Dimensions vary according to number of modules from 539mm to 2300mm (module length 160mm)

Single Color Version	# of Modules	Length
LB-601	1 LED module	539mm
LB-602	2 LED module	699mm
LB-603	3 LED module	859mm
LB-604	4 LED module	1019mm
LB-605	5 LED module	1179mm
LB-606	6 LED module	1339mm
LB-607	7 LED module	1499mm
LB-608	8 LED module	1659mm
LB-609	9 LED module	1819mm
LB-610	10 LED module	1979mm
LB-611	11 LED module	2139mm
LB-612	12 LED module	2299mm



LED LIGHT BAR / LB-700 SERIES

TECHNICAL SPECIFICATIONS

- Operating Voltage:** 10-30V DC
- Consumption:** From 72W to 158W (according to modules/color/flashing frequency)
- Reverse polarity protection:** Yes
- Flashing Frequency:** 10 Flashing Patterns
- Type of Protection:** IP67

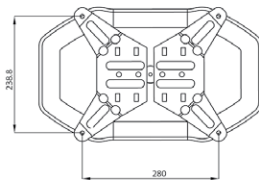
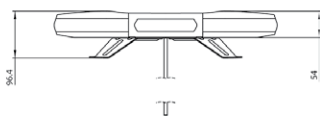
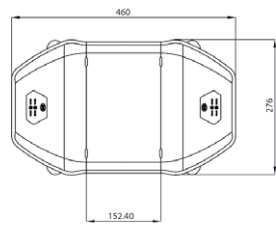

REF. No

- LB-7XX.05** Clear lens, Amber LEDs
- LB-7XX.06** Clear lens, Red LEDs
- LB-7XX.08** Clear lens, Blue LEDs
- LB-M-700.05** Spare LED Module Amber
- LB-M-700.06** Spare LED Module Red
- LB-M-700.08** Spare LED Module Blue

Where XX add number of LED modules (from 01 to 10)
 Dimensions vary according to number of modules from 458mm to 1829mm (module length 152mm)

Single Color Version	Single Color Version + White Alleys	# of Modules	Length
LB-701	LB-701W	1 LED module	458mm
LB-702	LB-702W	2 LED module	610mm
LB-703	LB-703W	3 LED module	763mm
LB-704	LB-704W	4 LED module	915mm
LB-705	LB-705W	5 LED module	1065mm
LB-706	LB-706W	6 LED module	1220mm
LB-707	LB-707W	7 LED module	1372mm
LB-708	LB-708W	8 LED module	1525mm
LB-709	LB-709W	9 LED module	1677mm
LB-710	LB-710W	10 LED module	1829mm

Available Connection Versions

- * Add
- .C for cable Exit
- .S for Switch Control
- .R for Wireless Remote Control

ECE APPROVED EMC APPROVED



LED LIGHT BAR / LB-800 SERIES

TECHNICAL SPECIFICATIONS

- Operating Voltage:** 10-30V DC
- Consumption:** 8-11W
- Reverse polarity protection:** Yes
- Flashing Frequency:** 10 Flashing Patterns
- Type of Protection:** IP67

REF. No

- LB-803.05** Light Bar with 3 modules
- LB-804.05** Light Bar with 4 modules
- LB-805.05** Light Bar with 5 modules
- LB-806.05** Light Bar with 6 modules

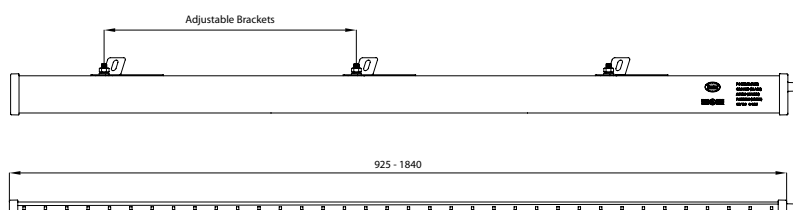

LED MINI LIGHT BAR

TECHNICAL SPECIFICATIONS

Operating Voltage:	10-30V DC
Operating Temperature:	-40 °C to +65 °C
Consumption:	From 28 to 56W (depends on the flashing frequency)
Reverse polarity protection:	Yes
Flashing Frequency:	10 flashing patterns
Flash rate:	150 fpm (single flash)
Type of Protection:	IP67

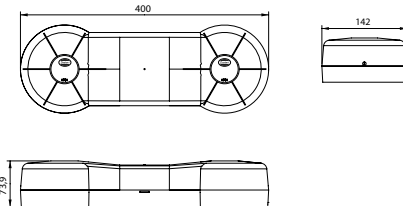

ECE APPROVED

WITH FLAT BASE

REF. No	
LB-450.05	Clear lens, Amber LEDs
LB-450.06	Clear lens, Red LEDs
LB-450.08	Clear lens, Blue LEDs

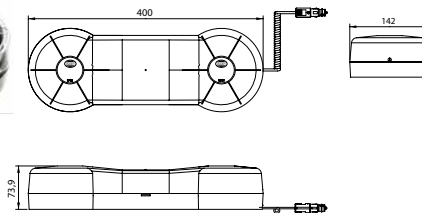

ECE APPROVED

WITH MAGNETIC BASE

REF. No	
LB-450M.05	Clear lens, Amber LEDs
LB-450M.06	Clear lens, Red LEDs
LB-450M.08	Clear lens, Blue LEDs

SPARE LENS

REF. No	
P-LB-450	Clear

MINI ROTATING LIGHT BAR

TECHNICAL SPECIFICATIONS

Operating Voltage:	12 or 24V DC
Consumption:	12V 2x55W (H1) / 24V 2x70W (H1)
Flash rate:	210 fpm/unit
Type of Protection:	IP54

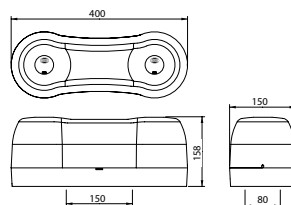

ECE APPROVED

WITH FLAT BASE

REF. No	
LBR-460.05	Amber lens
LBR-460.06	Red lens
LBR-460.08	Blue lens

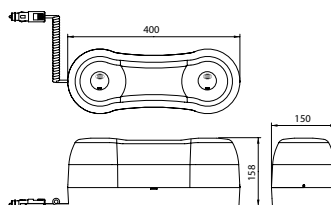

ECE APPROVED

WITH MAGNETIC BASE

REF. No	
LBR-460M.05	Amber lens
LBR-460M.06	Red lens
LBR-460M.08	Blue lens

SPARE LENS

REF. No	
P-LBR-460.05	Amber lens
P-LBR-460.06	Red lens
P-LBR-460.08	Blue lens

DSL-X10 SERIES

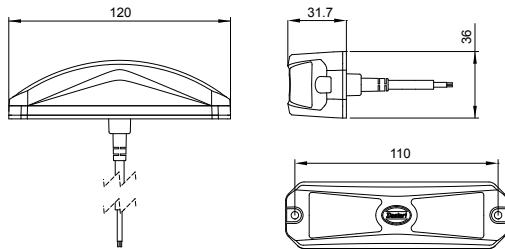

ECE APPROVED EMC APPROVED

TECHNICAL SPECIFICATIONS

Operating Voltage: 10-30V DC
Operating Temperature: -40 °C to +65 °C
Consumption: 9-13W depending on color and pattern
Flashing Frequency: 10 flashing patterns
Type of Protection: IP67

REF. No

DSL-X10.05 Clear lens, Amber LEDs
DSL-X10.06 Clear lens, Red LEDs
DSL-X10.07 Clear lens, White LEDs
DSL-X10.08 Clear lens, Blue LEDs

DSL-X20 SERIES

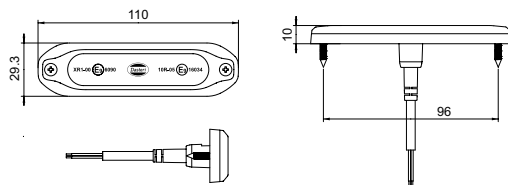

ECE APPROVED EMC APPROVED

TECHNICAL SPECIFICATIONS

Operating Voltage: 10-30V DC
Operating Temperature: -40 °C to +65 °C
Consumption: 6-17W depending on color and pattern
Flashing Frequency: 10 flashing patterns
Type of Protection: IP67

REF. No

DSL-X20.05 Clear lens, Amber LEDs
DSL-X20.06 Clear lens, Red LEDs
DSL-X20.07 Clear lens, White LEDs
DSL-X20.08 Clear lens, Blue LEDs

NEW

DSL-X25 SERIES

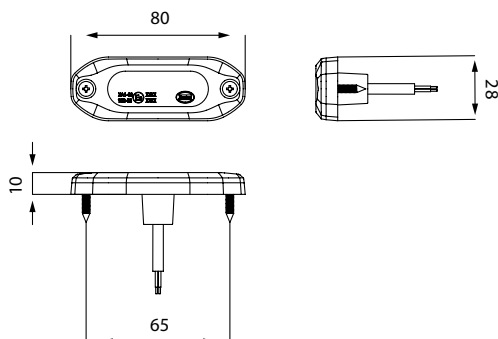

ECE APPROVED EMC APPROVED

TECHNICAL SPECIFICATIONS

Operating Voltage: 10-30V DC
Consumption: Amber: 8.7W, Red: 6.5W, Blue: 8W
Type of Protection: IP69K
Cable/Connector: 300 mm cable

REF. No	Amber	Red	Blue	Synch	Synch & Asynch
DSL-X25.05	•				•
DSL-X25.06		•			•
DSL-X25.08			•		•

NEW

DSL-X30C1 SERIES

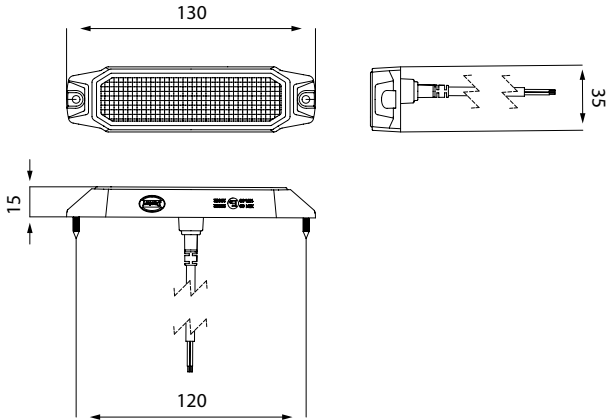

ECE APPROVED

EMC APPROVED

TECHNICAL SPECIFICATIONS

Operating Voltage: 10-30V DC
Consumption: Amber: 10W, Red: 3W, Blue: 5W
Type of Protection: IP69K
Cable/Connector: 300 mm cable

REF. No	Amber	Red	Blue
DSL-X30C1.05	●		
DSL-X30C1.06		●	
DSL-X30C1.08			●



NEW

DSL-X30C2 SERIES

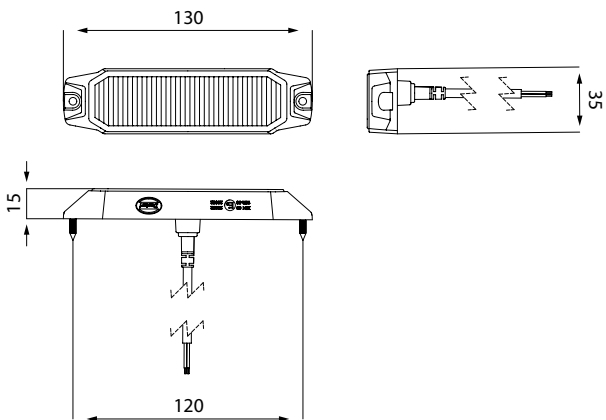

ECE APPROVED

EMC APPROVED

TECHNICAL SPECIFICATIONS

Operating Voltage: 10-30V DC
Consumption: Amber: 14W, Red: 4W, Blue: 7W
Type of Protection: IP69K
Cable/Connector: 300 mm cable

REF. No	Amber	Red	Blue
DSL-X30C2.05	●		
DSL-X30C2.06		●	
DSL-X30C2.08			●



NEW

LED WARNING / WORK LAMP



REF. No

WRKX-LED-300

TECHNICAL SPECIFICATIONS

Operating Voltage: 10-30V DC
Operating Temperature: -40 °C to +65 °C
Consumption: Warning 8W, Work 30W
Type of Protection: IP69K
Output: 3000lm

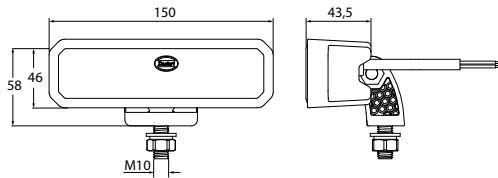

ECE APPROVED

EMC APPROVED

NEW

LED WARNING / WORK LAMP



REF. No

WRKX-LED-310

TECHNICAL SPECIFICATIONS

Operating Voltage: 10-30V DC
Operating Temperature: -40 °C to +65 °C
Consumption: Warning 12W, Work 40W
Type of Protection: IP69K
Output: 2850lm

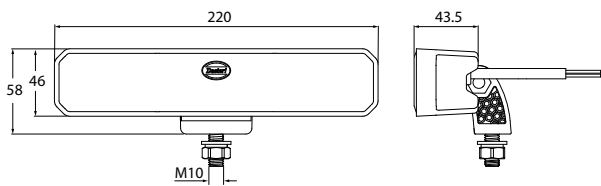

ECE APPROVED

EMC APPROVED

LED FLASHING LAMP

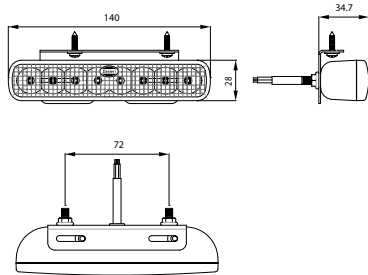

TECHNICAL SPECIFICATIONS

Operating Voltage: 10 - 30V DC
Operating Temperature: -40 °C to +65 °C
Consumption: 3,3W
Type of Protection: IP67

REF. No

DSL-108X.05 Clear lens, Amber LEDs
DSL-108X.06 Clear lens, Red LEDs
DSL-108X.07 Clear lens, White LEDs
DSL-108X.08 Clear lens, Blue LEDs

LED FLASHING LAMP GHOST SERIES

TECHNICAL SPECIFICATIONS

Operating Voltage: 10-30V DC
Operating Temperature: -40 °C to +65 °C
Consumption: 18W
Flashing Frequency: 3 flashing patterns / 33 flashing patterns
Type of Protection: IP67

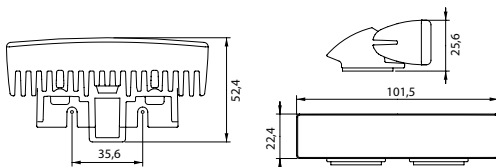

ECE APPROVED

MULTI-MOUNT - 3 PATTERNS (ECE APPROVED)

REF. No

DSL-GHST1A Amber LEDs chrome housing
DSL-GHST1B Blue LEDs chrome housing
DSL-GHST1R Red LEDs chrome housing

MULTI-MOUNT - 33 PATTERNS

REF. No

DSL-GHST1AS Amber LEDs
DSL-GHST1BS Blue LEDs
DSL-GHST1RS Red LEDs
DSL-GHST1W Clear LEDs
DSL-GHST1J Blue-Red LEDs

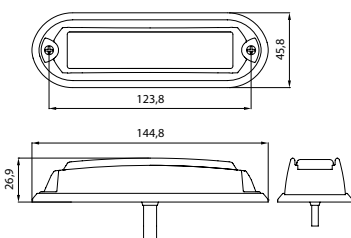

ECE APPROVED

SURFACE - MOUNT - 3 PATTERNS (ECE APPROVED)

REF. No

DSL-GHST2AC Amber LEDs
DSL-GHST2BC Blue LEDs
DSL-GHST2RC Red LEDs

SURFACE - MOUNT - 33 PATTERNS

REF. No

DSL-GHST2AS Amber LEDs
DSL-GHST2BS Blue LEDs
DSL-GHST2RS Red LEDs
DSL-GHST2W Clear LEDs
DSL-GHST2J Blue-Red LEDs



MULTI- FUNCTIONAL REAR LAMPS





7-FUNCTION REAR LED LAMP / DSL-2030 SERIES

TECHNICAL SPECIFICATIONS

- Functions:** Reversing, Fog, Tail, Reflex Reflector, Stop, Direction Indicator, End Outline Lamp, Side Marker
- Optional Functions:** Number Plate Lamp
- Operating Voltage:** 24V
- Consumption:** Rev.: 1,5W Fog: 3,1W Tail: 0,3W Stop: 1,7W D.I.: 2,1W
End Out.: 0,15W S.M.: 1W N.P.L.: 1W
- Type of Protection:** IP67 for modules

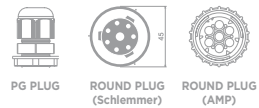
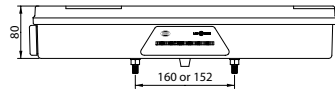
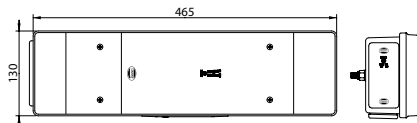

ECE APPROVED

REF. No	NUMBER PLATE (PL)	PG PLUG (50 cm Cable)	ROUND PLUG (Schlemmer)	ROUND PLUG (7 pin AMP)
DSL-2030SR (R)		•		
DSL-2031SR (L)				
DSL-2031PLSR (L)	•	•		
DSL-2032SR (R)			•	
DSL-2033SR (L)				
DSL-2033PLSR (L)	•		•	
DSL-2036SR (R)				ON THE SIDE
DSL-2037SR (L)				ON THE SIDE
DSL-2037PLSR (L)	•			ON THE SIDE

NOTES: L: LEFT (side) / R: RIGHT (side)

SPARE LENS AVAILABLE REF. NO DSL-P-2030
U.K. VERSIONS AVAILABLE FOR ALL TYPES

7-FUNCTION REAR LED LAMP / DSL-2040 SERIES

TECHNICAL SPECIFICATIONS

Functions: Reversing, Fog, Tail, Reflex Reflector, Stop, Direction Indicator, End Outline Lamp, Side Marker
Optional Functions: Number Plate Lamp
Operating Voltage: 24V
Consumption: Rev.: 1,5W Fog: 3,1W Tail: 0,3W Stop: 1,7W D.I.: 2,1W End Out.: 0,15W S.M.: 1W N.P.L.: 1W
Type of Protection: IP67

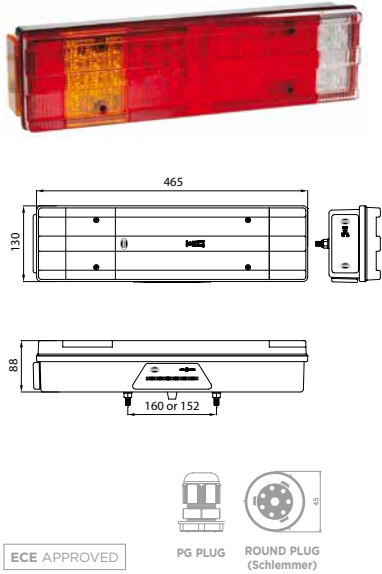

REF. No	NUMBER PLATE (PL)	PG PLUG (50 cm Cable)	ROUND PLUG (Schlemmer)
DSL-2040SR (R) DSL-2041SR (L)		•	
DSL-2041PLSR (L)	•	•	
DSL-2042SR (R) DSL-2043SR (L)			•
DSL-2043PLSR (L)	•		•

NOTES: L: LEFT (side) / R: RIGHT (side) SPARE LENS AVAILABLE REF. NO DSL-P-2040 U.K. VERSIONS AVAILABLE FOR ALL TYPES

7-FUNCTION REAR LED LAMP / DSL-2050 SERIES

TECHNICAL SPECIFICATIONS

Functions: Reversing, Fog, Tail, Reflex Reflector, Stop, Direction Indicator, End Outline Lamp, Side Marker
Optional Functions: Number Plate Lamp
Operating Voltage: 24V
Consumption: Rev.: 1,5W Fog: 3,1W Tail: 0,3W Stop: 1,7W D.I.: 2,1W End Out.: 0,15W S.M.: 1W N.P.L.: 1W
Type of Protection: IP67 for modules

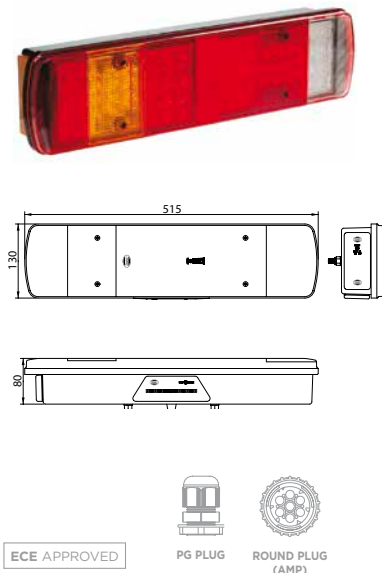

REF. No	NUMBER PLATE (PL)	PG PLUG (50 cm Cable)	ROUND PLUG (AMP On the side)
DSL-2050SR (R) DSL-2051SR (L)		•	
DSL-2051PLSR (L)	•	•	
DSL-2050SR.S (R) DSL-2051SR.S (L)		• BOTTOM SIDE	
DSL-2054SR For VOLVO (R) DSL-2055SR (L)			
DSL-2055PLSR For VOLVO (L)	•		
DSL-2054SR.S For SCANIA (R)			
DSL-2054SR162 For SCANIA R (R)			
DSL-2055PLSR163 For SCANIA R (L)	•		
DSL-2054SR167 For SCANIA (R)			•
DSL-2055PLSR.S For SCANIA (L)	•		•

NOTES: L: LEFT (side) / R: RIGHT (side) SPARE LENS AVAILABLE REF. NO DSL-P-2050 U.K. VERSIONS AVAILABLE FOR ALL TYPES

6-FUNCTION REAR LED LAMP / DSL-2060 SERIES

TECHNICAL SPECIFICATIONS

Functions: Stop, Tail, Fog, Reverse, Direction Indicator, Reflex Reflector
Operating Voltage: 10 - 30V DC
Consumption: Stop 1,5W Tail, 0,5W Rev. 2W, Fog 2,5W, D.I. 1,5W
Type of Protection: IP67

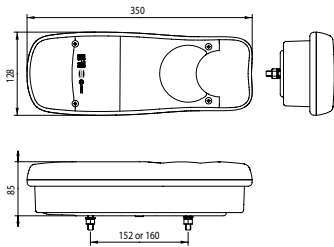

REF. No	PG PLUG (50 CM CABLE)	ROUND PLUG (AMP)	PG PLUG WITH 1m DUAL CABLE
DSL-2060 (R) DSL-2061 (L)	•		
DSL-2062 (R) DSL-2063 (L)		•	
DSL-2064 (R) DSL-2065 (L)		•	•

NOTES: L: LEFT (side) / R: RIGHT (side)
 * NOT AVAILABLE FOR GERMAN MARKET
 SPARE LENS AVAILABLE REF. NO DSL-P-2060
 U.K. VERSIONS AVAILABLE FOR ALL TYPES

6-FUNCTION REAR LED LAMP / DSL-2060D SERIES

TECHNICAL SPECIFICATIONS

Functions: Stop, Tail, Reversing, Fog, D.I., Reflex Reflector
Operating Voltage: 10 - 30V DC
Consumption: Stop 1,5W Tail 0,5W Fog 2,5W Rev 2W D.I. 1,5W
Type of Protection: IP67

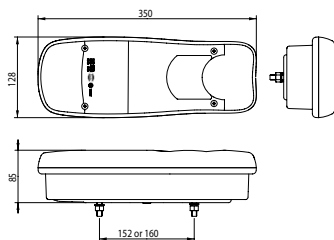

REF. No	PG PLUG (50 CM CABLE)	ROUND PLUG (AMP)	PG PLUG WITH 1m DUAL CABLE
DSL-2060D (R) DSL-2061D (L)	•		
DSL-2062D (R) DSL-2063D (L)		•	
DSL-2064D (R) DSL-2065D (L)		•	•

NOTES: L: LEFT (side) / R: RIGHT (side)
 * NOT AVAILABLE FOR GERMAN MARKET
 SPARE LENS AVAILABLE REF. NO DSL-P-2060D
 U.K. VERSIONS AVAILABLE FOR ALL TYPES

7-FUNCTION REAR LED LAMP / DSL-2100 SERIES

TECHNICAL SPECIFICATIONS

Functions: Reversing, Fog, Double Tail, Triangle Reflex Reflector, Double Stop, Double Direction Indicator, End Outline Lamp, Side Marker
Operating Voltage: 10-30V
Consumption: (12/24V) Rev.: 3/3W Fog: 4/4W Tail: 2x 3/4W Stop: 2x 3/4W D.I.: 2x 3/4W S.M.: 0,8/0,8W
Type of Protection: IP67 for modules

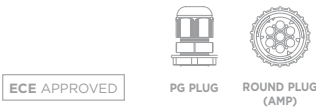
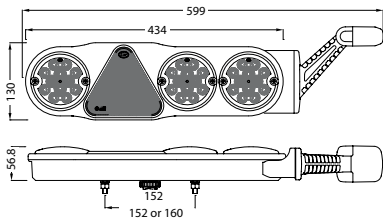

REF. No		REVERSING LAMP	REAR FOG	LED MARKER LAMP	ROUND PLUG (7pin AMP)	PG PLUG (50 cm Cable)
DSL-2100TR	(R)	●				●
DSL-2101TR	(L)		●			●
DSL-2102TR	(R)	●			●	
DSL-2103TR	(L)		●		●	
DSL-2104TR	(R)	●	●		●	
DSL-2105TR	(L)	●	●		●	
DSL-2106TR	(R)	●	●			●
DSL-2107TR	(L)	●	●			●
DSL-2102TR630	(R)	●		●	●	
DSL-2103TR630	(L)		●	●	●	
DSL-2104TR630	(R)	●	●	●	●	
DSL-2105TR630	(L)	●	●	●	●	

NOTES: L: LEFT (side) / R: RIGHT (side)

U.K. VERSIONS AVAILABLE FOR ALL TYPES

6-FUNCTION REAR LED LAMP / DSL-0500 SERIES

TECHNICAL SPECIFICATIONS

Functions: Reversing, Fog, Double Tail, Double Stop, Double Direction Indicator, Side Marker
Operating Voltage: 10-30V
Consumption: Fog: 4W Rev: 3W D.I.: 2x2W Tail: 2x1W Stop: 2x2W
Type of Protection: IP67

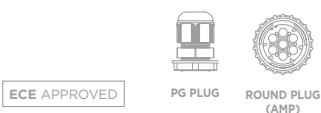
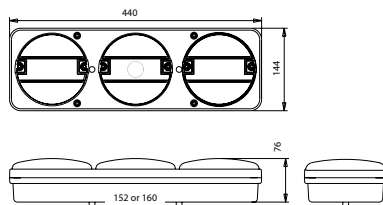

REF. No		REVERSING LAMP	REAR FOG	PG PLUG	ROUND PLUG (AMP On the side)	ALL LED UNITS WITH COLORED LENS	ALL LED UNITS WITH CLEAR LENS
DSL-0500SR	(R)	●		●		●	
DSL-0501SR	(L)		●	●		●	
DSL-0502SR	(R)	●			●	●	
DSL-0503SR	(L)		●		●	●	
DSL-0506SR	(R)	●			ON THE SIDE	●	
DSL-0507SR	(L)		●		ON THE SIDE	●	
DSL-0500SR07	(R)	●		●			●
DSL-0501SR07	(L)		●	●			●
DSL-0502SR07	(R)	●			●		●
DSL-0503SR07	(L)		●		●		●
DSL-0506SR07	(R)	●			ON THE SIDE		●
DSL-0507SR07	(L)		●		ON THE SIDE		●

NOTES: L: LEFT (side) / R: RIGHT (side)

DSL-0500 & DSL-0500.07 series, are available in all possible combinations obtained with the use of LED UNITS / U.K. VERSIONS AVAILABLE FOR ALL TYPES

6-FUNCTION REAR LED LAMP / DSL-180 SERIES

TECHNICAL SPECIFICATIONS

Functions: Reversing, Fog, Tail, Stop, Direction Indicator, Side Marker, Triangle Reflex Reflector
Operating Voltage: 10-30V DC
Consumption: (12/24V) Reversing: 2,3/2,4W Fog: 2,7/2,7W Stop: 0,6/0,8W Tail: 3,4/3,6W D.I.: 3/3,4W S.M.: 1/1W
Type of Protection: IP67 for modules

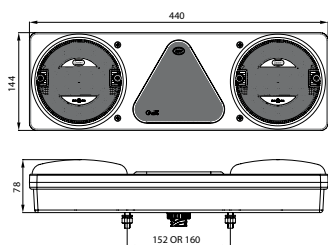

ECE APPROVED



PG PLUG



ROUND PLUG (AMP)

REF. No	REVERSING LAMP	REAR FOG	PG PLUG	ROUND PLUG (AMP)
DSL-180WTRSR (R)	●		●	
DSL-181FTRSR (L)		●	●	
DSL-182WTRSR (R)	●			●
DSL-183FTRSR (L)		●		●
DSL-186WTRSR (R)	●			ON THE SIDE
DSL-187FTRSR (L)		●		ON THE SIDE
DSL-180WFTRSR (R)	●	●	●	
DSL-181WFTRSR (L)	●	●	●	
DSL-182WFTRSR (R)	●	●		●
DSL-183WFTRSR (L)	●	●		●
DSL-186WFTRSR (R)	●	●		ON THE SIDE
DSL-187WFTRSR (L)	●	●		ON THE SIDE

NOTES: L: LEFT (side) / R: RIGHT (side) DSL-180TRSR series, is available in all possible combinations obtained with the use of ECO LINE LED LAMPS U.K. VERSIONS AVAILABLE FOR ALL TYPES

6-FUNCTION REAR LED LAMP / DSL-2200 SERIES

TECHNICAL SPECIFICATIONS

Functions: Reversing, Fog, Double Tail, Stop, Double Direction Indicator, Side Marker, Triangle Reflex Reflector
Operating Voltage: 12 or 24V DC
Consumption: Tail: 2x0,3W Fog: 2W Stop: 2x2W D.I.: 2x1,5W
Type of Protection: IP67
Available Housings: Black

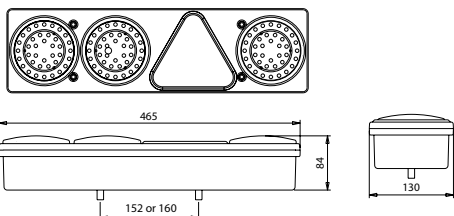

ECE APPROVED

ROUND PLUG (AMP)

REF. No	REVERSING LAMP	REAR FOG	BLACK FACE
DSL-2202SR (R)	●		●
DSL-2203SR (L)		●	●

NOTES: L: LEFT (side) / R: RIGHT (side) U.K. VERSIONS AVAILABLE FOR ALL TYPES

7-FUNCTION REAR FULL LED OR HYBRID LAMP / DSL-2300 SERIES

TECHNICAL SPECIFICATIONS

- Functions:** Reversing, Fog, Stop, Tail, Reflex Reflector, Direction Indicator
- Optional Functions:** End Outline LED Lamp
- Operating Voltage:** 10-30V DC
- Consumption:** Reversing 2.86W, Fog 2.1W, Stop 2.1W, Tail 0.63W, Direction Indicator 1.92W
- Type of Protection:** IP67

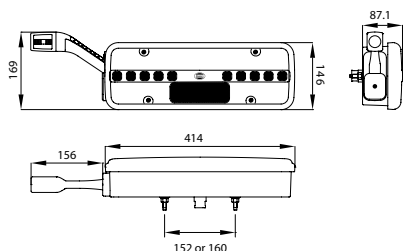

ECE APPROVED

PG PLUG

ROUND PLUG (AMP)

REF. No	FUNCTIONS	LED END OUTLINE LAMP	PG PLUG	AMP
DSL-2300H (R)	Hybrid	●	●	
DSL-2301H (L)	Hybrid	●	●	
DSL-2302H (R)	Hybrid		●	
DSL-2303H (L)	Hybrid		●	
DSL-2304H (R)	Hybrid	●		●
DSL-2305H (L)	Hybrid	●		●
DSL-2306H (R)	Hybrid			●
DSL-2307H (L)	Hybrid			●
DSL-2300 (R)	Full Led	●	●	
DSL-2301 (L)	Full Led	●	●	
DSL-2302 (R)	Full Led		●	
DSL-2303 (L)	Full Led		●	
DSL-2304 (R)	Full Led	●		●
DSL-2305 (L)	Full Led	●		●
DSL-2306 (R)	Full Led			●
DSL-2307 (L)	Full Led			●

NOTES: L: LEFT (side) / R: RIGHT (side)

7-FUNCTION REAR HYBRID LAMP / DSL-2300TR SERIES

TECHNICAL SPECIFICATIONS

- Functions:** Reversing, Fog, Stop, Tail, Triangle Reflex Reflector, Direction Indicator
- Optional Functions:** End Outline LED Lamp
- Operating Voltage:** 10-30V DC
- Consumption:** Reversing 2.86W, Fog 2.1W, Stop 2.1W, Tail 0.63W, Direction Indicator 1.92W
- Type of Protection:** IP67

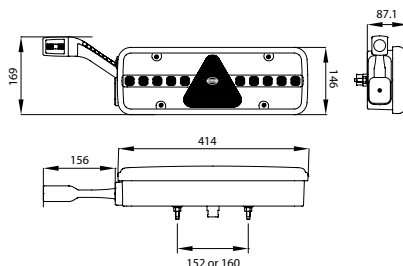

ECE APPROVED

PG PLUG

ROUND PLUG (AMP)

REF. No	FUNCTIONS	LED END OUTLINE LAMP	PG PLUG	AMP
DSL-2300HTR (R)	Hybrid	●	●	
DSL-2301HTR (L)	Hybrid	●	●	
DSL-2302HTR (R)	Hybrid		●	
DSL-2303HTR (L)	Hybrid		●	
DSL-2304HTR (R)	Hybrid	●		●
DSL-2305HTR (L)	Hybrid	●		●
DSL-2306HTR (R)	Hybrid			●
DSL-2307HTR (L)	Hybrid			●
DSL-2300TR (R)	Full Led	●	●	
DSL-2301TR (L)	Full Led	●	●	
DSL-2302TR (R)	Full Led		●	
DSL-2303TR (L)	Full Led		●	
DSL-2304TR (R)	Full Led	●		●
DSL-2305TR (L)	Full Led	●		●
DSL-2306TR (R)	Full Led			●
DSL-2307TR (L)	Full Led			●

NOTES: L: LEFT (side) / R: RIGHT (side)

6-FUNCTION REAR LED LAMP / DSL-5000 SERIES



TECHNICAL SPECIFICATIONS

Functions: Stop, Tail, Dynamic Direction Indicator, Fog, Reversing, Reflex Reflector
Operating Voltage: 10-30 V
Consumption: S: 2W T: 3.2W F: 4W D.I.: 3.5W R: 2.5W
Type of Protection: IP67

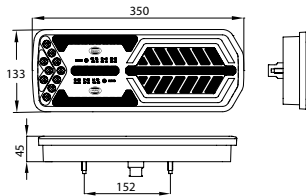

Available in **Black Version**
 Dynamic DI

ECE APPROVED EMC APPROVED

REF. No	CABLE EXIT	7-PIN AMP	GREY BEZEL	BLACK BEZEL	Load Module for Indicator Failure Control
DSL-5000	●		●		Add M12 or M24 to REF No M12 for 12V M24 for 24V
DSL-5001	●		●		
DSL-5002		●	●		
DSL-5003		●	●		
DSL-5000B	●			●	
DSL-5001B	●			●	
DSL-5002B		●		●	
DSL-5003B		●		●	

6-FUNCTION REAR LED LAMP / DSL-5000TR SERIES



TECHNICAL SPECIFICATIONS

Functions: Stop, Tail, Dynamic Direction Indicator, Fog, Reversing, Triangle Reflex Reflector
Operating Voltage: 10-30V
Consumption: S: 2W T: 3.2W F: 4W D.I.: 3.5W R: 2.5W
Type of Protection: IP67

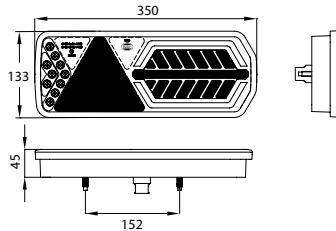

Available in **Black Version**
 Dynamic DI

ECE APPROVED EMC APPROVED

REF. No	CABLE EXIT	7-PIN AMP	BLACK CAPS	Load Module for Indicator Failure Control
DSL-5000TR (R)	●			Add M12 or M24 to REF No M12 for 12V M24 for 24V
DSL-5001TR (L)	●			
DSL-5002TR (R)		●		
DSL-5003TR (L)		●		
DSL-5000TRB (R)			●	
DSL-5001TRB (L)			●	
DSL-5002TRB (R)			●	
DSL-5003TRB (L)			●	

NOTES: L: LEFT (side) / R: RIGHT (side).

6-FUNCTION REAR LED LAMP / DSL-5100 SERIES



TECHNICAL SPECIFICATIONS

Functions: Stop, Tail, Dynamic Direction Indicator, Fog, Reversing, Reflex Reflector
Operating Voltage: 10-30V
Consumption: S: 2W T: 2.6W F: 4.8W D.I.: 3.8W R: 2W
Type of Protection: IP67

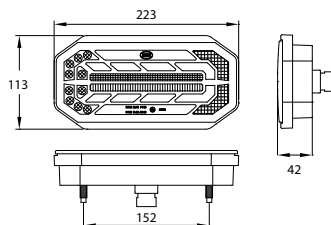

Available in **Black Version**
 Dynamic DI

ECE APPROVED EMC APPROVED

REF. No	CABLE EXIT	7-PIN AMP	GREY BEZEL	BLACK BEZEL	Load Module for Indicator Failure Control
DSL-5100	●		●		Add M12 or M24 to REF No M12 for 12V M24 for 24V
DSL-5101	●		●		
DSL-5102		●	●		
DSL-5103		●	●		
DSL-5100B	●			●	
DSL-5101B	●			●	
DSL-5102B		●		●	
DSL-5103B		●		●	

NOTES: L: LEFT (side) / R: RIGHT (side)



6-FUNCTION REAR LED LAMP / DSL-5200 SERIES



TECHNICAL SPECIFICATIONS

- Functions:** Stop, Tail, Dynamic Direction Indicator, Fog, Reversing, Reflex Reflector (rectangular), Number Plate (Optional)
- Optional Functions:** Up to 2x2-pin AMP superseal connectors
- Operating Voltage:** 10-30 V
- Consumption:** S: 3.4W T: 2.9W F:4.5W D.I.: 3.1W R: 3.1W
- Type of Protection:** IP67

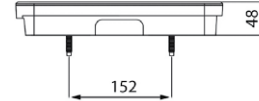
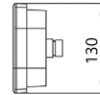
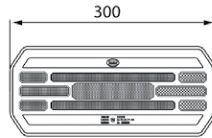

Available in Black Version



ECE APPROVED

EMC APPROVED

REF. No.	TRUCK	LEFT	RIGHT	CABLE	7-PIN AMP	2X2-PIN AMP SUPERSEAL	NUMBER PLATE LAMP	GREY BEZEL	BLACK BEZEL
DSL-5200	•		•	•				•	
DSL-5201	•	•		•				•	
DSL-5202	•		•		•			•	
DSL-5203	•	•			•			•	
DSL-5204	•		•		•	•		•	
DSL-5205	•	•			•	•		•	
DSL-5205PL	•	•			•	•	•	•	
DSL-5200B	•		•	•					•
DSL-5201B	•	•		•					•
DSL-5202B	•		•		•				•
DSL-5203B	•	•			•				•
DSL-5204B	•		•		•	•			•
DSL-5205B	•	•			•	•			•
DSL-5205BPL	•	•			•	•	•		•

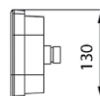
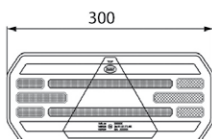

Available in Black Version

ECE APPROVED

EMC APPROVED

REF. No.	TRAILER	LEFT	RIGHT	CABLE	7-PIN AMP	2X2-PIN AMP SUPERSEAL	GREY BEZEL	BLACK BEZEL	LED END OUTLINE MARKER LAMP
DSL-5200TR	•		•	•			•		
DSL-5201TR	•	•		•			•		
DSL-5202TR	•		•		•		•		
DSL-5203TR	•	•			•		•		
DSL-5204TR	•		•		•	•	•		
DSL-5205TR	•	•			•	•	•		
DSL-5200TRB	•		•		•			•	
DSL-5201TRB	•	•		•				•	
DSL-5202TRB	•		•	•				•	
DSL-5203TRB	•	•			•			•	
DSL-5204TRB	•		•		•	•		•	
DSL-5205TRB	•	•			•	•		•	

For DSL-620S add to ref code .620S/12 for 12V or .620S/24 for 24V

For DSL-622S add to ref code .622S/12 for 12V or .622S/24 for 24V

6-FUNCTION REAR LED LAMP / DSL-6000 SERIES



TECHNICAL SPECIFICATIONS

- Functions:** Tail, Stop, Fog, Reverse, Reflex Reflector, Direction Indicator
- Optional Functions:** Up to 4x2-pin AMP superseal connectors
- Direction Indicator Light:** 3.6 W
- Tail Light:** 3.2 W
- Stop Light:** 3.2 W
- Fog Light:** 3.2 W
- Reverse Light:** 1.6 W
- Operating Voltage:** 10V-30V
- Type of Protection:** IP67

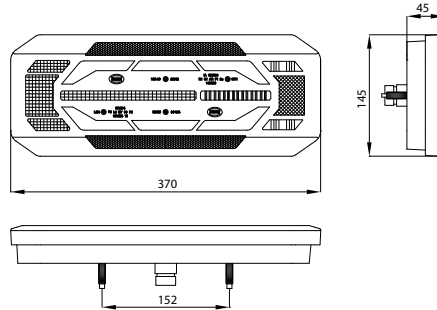

Available in
Black Version

ECE APPROVED

EMC APPROVED

REF. No	TRUCK	TRAILER	LEFT	RIGHT	CABLE	7-pin AMP	4x2-pin AMP superseal	NUMBER PLATE LAMP	BLACK VERSION	Load Module for Indicator Failure Control
DSL-6000	•			•	•					
DSL-6001	•		•		•					
DSL-6002	•			•		•				
DSL-6003	•		•			•				
DSL-6004	•			•		•	•			
DSL-6005	•		•			•	•			
DSL-6005PL	•		•		•	•	•	•		Add M to Ref. No.
DSL-6000B	•			•	•				•	
DSL-6001B	•		•			•			•	
DSL-6002B	•			•		•			•	
DSL-6003B	•		•			•	•		•	
DSL-6004B	•			•		•	•		•	
DSL-6005B	•		•			•	•		•	
DSL-6005BPL	•		•					•	•	

6-FUNCTION REAR LED LAMP / DSL-6000TR SERIES



TECHNICAL SPECIFICATIONS

- Functions:** Tail, Stop, Fog, Reverse, Triangle Reflex Reflector, Direction Indicator
- Optional Functions:** Up to 4x2-pin AMP superseal connectors, End Outline lamp
- Direction Indicator Light:** 3.6 W
- Tail Light:** 3.2 W
- Stop Light:** 3.2 W
- Fog Light:** 3.2 W
- Reverse Light:** 1.6 W
- Operating Voltage:** 10V-30V
- Type of Protection:** IP67

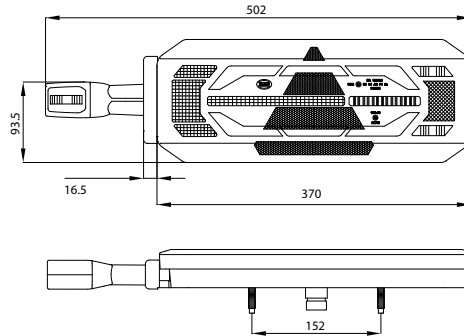

Available in
Black Version

ECE APPROVED

EMC APPROVED

REF. No	TRUCK	TRAILER	LEFT	RIGHT	CABLE	7-pin AMP	4x2-pin AMP superseal	BLACK VERSION	Load Module for Indicator Failure Control	Load End Outline Marker Lamp
DSL-6000TR		•		•	•				Add M to Ref. No.	For DSL-620 add to Ref. code .620/12 for 12V or .620/24 for 24V
DSL-6001TR		•	•		•					
DSL-6002TR		•		•		•				
DSL-6003TR		•	•			•				
DSL-6004TR		•		•		•	•			
DSL-6005TR		•	•			•	•			
DSL-6000TRB		•		•	•			•		For DSL-622 add to Ref. code .622/12 for 12V or .622/24 for 24V
DSL-6001TRB		•	•		•			•		
DSL-6002TRB		•		•		•		•		
DSL-6003TRB		•	•			•		•		
DSL-6004TRB		•		•		•	•	•		
DSL-6005TRB		•	•			•	•	•		



6-FUNCTION REAR LED LAMP / DSL-7000 SERIES



TECHNICAL SPECIFICATIONS

- Functions:** Stop, Tail, Dyn DI, Fog, Reverse, Reflex Reflector (rectangular)
- Optional Functions:** Up to 4x2-pin AMP superseal connectors
- Consumption:** S: 2W T: 2.8W F: 3.8W D.I.: 2.8W R: 2.3W
- Operating Voltage:** 10V-30V
- Type of Protection:** IP67

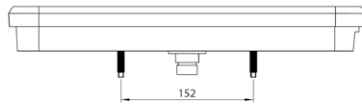
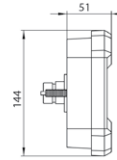
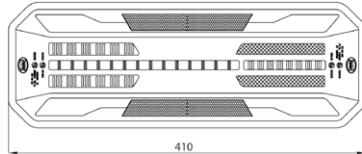

Available in Black Version

ECE APPROVED

EMC APPROVED

REF. No	TRUCK	TRAILER	LEFT	RIGHT	CABLE	7-pin AMP	4x2-pin AMP superseal	NUMBER PLATE LAMP	BLACK VERSION	Load Module for Indicator Failure Control	Load End Outline Marker Lamp
DSL-7000	•			•	•					Add M to Ref. No.	—
DSL-7001	•		•		•						
DSL-7002	•			•		•					
DSL-7003	•		•			•					
DSL-7004	•			•		•	•				
DSL-7005	•		•			•	•				
DSL-7005PL	•		•		•	•	•	•			
DSL-7000B	•			•	•				•		
DSL-7001B	•		•			•			•		
DSL-7002B	•			•		•			•		
DSL-7003B	•		•			•	•		•		
DSL-7004B	•			•		•	•		•		
DSL-7005B	•		•			•	•		•		
DSL-7005BPL	•		•					•	•		

NOTES: L: LEFT (side) / R: RIGHT (side)



6-FUNCTION REAR LED LAMP / DSL-7000TR SERIES



TECHNICAL SPECIFICATIONS

- Functions:** Stop, Tail, Dyn DI, Fog, Reverse, Reflex Reflector (triangle)
- Optional Functions:** Up to 4x2-pin AMP superseal connectors, End Outline lamp
- Consumption:** S: 2W T: 2.8W F: 3.8W D.I.: 2.8W R: 2.3W
- Operating Voltage:** 10V-30V
- Type of Protection:** IP67

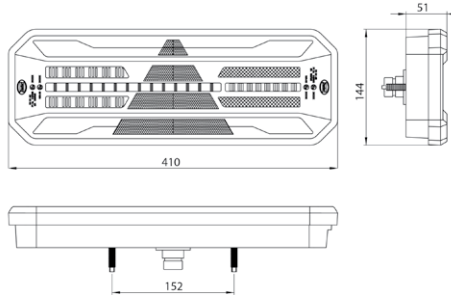

Available in Black Version

ECE APPROVED

EMC APPROVED

REF. No	TRAILER	LEFT	RIGHT	CABLE	7-pin AMP	4x2-pin AMP superseal	BLACK VERSION	Load Module for Indicator Failure Control	End Outline Marker Lamp
DSL-7000TR	•		•	•				Add M to Ref. No.	For DSL-620 add to Ref. code .620/12 for 12V or .620/24 for 24V For DSL-622 add to Ref. code .622/12 for 12V or .622/24 for 24V
DSL-7001TR	•	•		•					
DSL-7002TR	•		•		•				
DSL-7003TR	•	•			•				
DSL-7004TR	•		•		•	•			
DSL-7005TR	•	•			•	•			
DSL-7000TRB	•		•	•			•		
DSL-7001TRB	•	•		•			•		
DSL-7002TRB	•		•		•		•		
DSL-7003TRB	•	•			•		•		
DSL-7004TRB	•		•		•	•	•		
DSL-7005TRB	•	•			•	•	•		

6-FUNCTION REAR LED LAMP / DSL-4200RR SERIES

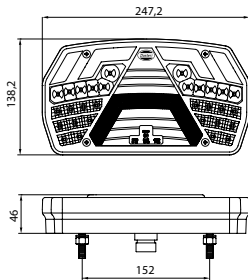

ECE APPROVED EMC APPROVED

Dynamic DI

TECHNICAL SPECIFICATIONS

Functions: Stop, Tail, Dynamic D.I. (optional), Fog, Reversing, Reflex Reflector
Operating Voltage: 10-30V DC
Consumption: S: 1.5W T: 2W D.I.: 1.5W F: 4W R: 1.5W
Type of Protection: IP67

REF. No	PG PLUG	ROUND PLUG (AMP)	DYNAMIC D.I.	Load Module for Indicator Failure Control
DSL-4202RR (R)	●			Add M12 or M24 to REF No M12 for 12V M24 for 24V
DSL-4203RR (L)	●			
DSL-4204RR (R)		●		
DSL-4205RR (L)		●		
DSL-D4202RR (R)	●		●	
DSL-D4203RR (L)	●		●	
DSL-D4204RR (R)		●	●	
DSL-D4205RR (L)		●	●	

NOTES: L: LEFT (side) / R: RIGHT (side)
 SPARE LENS FOR BOTH LEFT AND RIGHT ITEMS: DSL-P-4200D

6-FUNCTION REAR LED LAMP / DSL-4200 SERIES

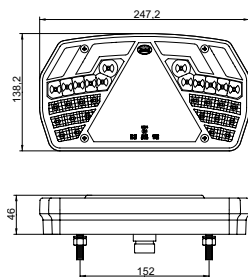

ECE APPROVED EMC APPROVED

Dynamic DI

TECHNICAL SPECIFICATIONS

Functions: Stop, Tail, Dynamic D.I. (optional), Fog, Reversing, Triangular Reflex Reflector
Operating Voltage: 10-30V DC
Consumption: S: 1.5W T: 2W D.I.: 1.5W F: 4W R: 1.5W
Type of Protection: IP67

REF. No	PG PLUG	ROUND PLUG (AMP)	DYNAMIC D.I.	Load Module for Indicator Failure Control
DSL-4202 (R)	●			Add M12 or M24 to REF No M12 for 12V M24 for 24V
DSL-4203 (L)	●			
DSL-4204 (R)		●		
DSL-4205 (L)		●		
DSL-D4202 (R)	●		●	
DSL-D4203 (L)	●		●	
DSL-D4204 (R)		●	●	
DSL-D4205 (L)		●	●	

NOTES: L: LEFT (side) / R: RIGHT (side)
 SPARE LENS FOR BOTH LEFT AND RIGHT ITEMS: DSL-P-4200

NEW

2-FUNCTION REAR LED LAMP

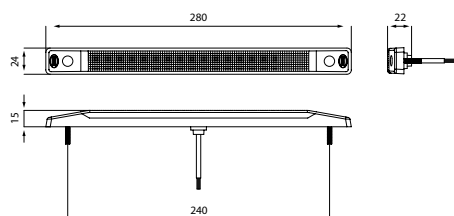

ECE APPROVED EMC APPROVED



REF. No
DSL-260ST.06 Red Lens
DSL-260ST.07 Clear Lens



TECHNICAL SPECIFICATIONS

Functions: Stop, Tail
Operating Voltage: 10-30V DC
Consumption: S: 3,5W, T: <0,5W
Type of Protection: IP67
Cable/Connector: 500 mm cable

NEW

2-FUNCTION REAR LED LAMP

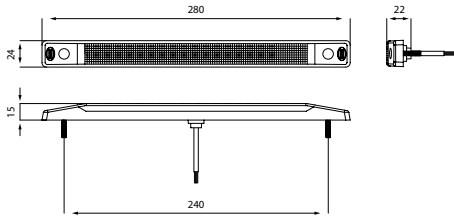

REF. No

DSL-260STD

Clear Lens

TECHNICAL SPECIFICATIONS

Functions: Stop, Tail, D.I
Operating Voltage: 10-30V DC
Consumption: S: 3,5W, T: <0,5W, D.I.: 3,5W
Type of Protection: IP67
Cable/Connector: 500 mm cable

ECE APPROVED

EMC APPROVED

4-FUNCTION REAR LED LAMP

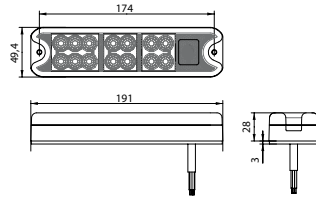

ECE APPROVED

REF. No

DSL-4010

For surface mounting

TECHNICAL SPECIFICATIONS

Functions: Tail, Stop, Direction Indicator, Reflex Reflector
Operating Voltage: 9-33V
Consumption: Stop: 1,5W Tail: 0,5W D.I.: 1,5W
Type of protection: IP67

3-FUNCTION REAR LED LAMP

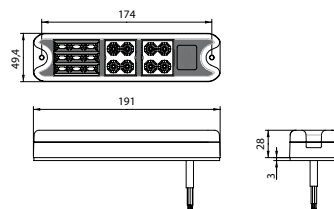

ECE APPROVED

REF. No

DSL-4010FR

For surface mounting

TECHNICAL SPECIFICATIONS

Functions: Fog, Reverse, Reflex Reflector
Operating Voltage: 10-30V DC
Consumption: Rev. 1,7W, Fog 2,9W
Type of protection: IP67

4-FUNCTION REAR LED LAMP

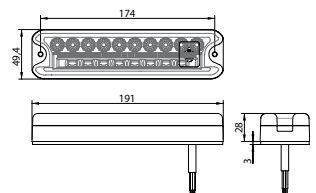

REF. No

DSL-4020

Right

DSL-4021

Left

TECHNICAL SPECIFICATIONS

Functions: Reversing, Tail, Stop, D. I., Reflex Reflector
Operating Voltage: 9-33V DC
Consumption: D.I.: 2W, Stop: 3W, Rev: 2W, Tail: 0,5W
Type of protection: IP67

NEW

3-FUNCTION REAR LED LAMP

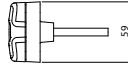
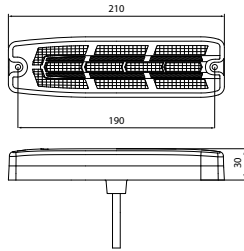

REF. No

DSL-4030

With Cable exit

TECHNICAL SPECIFICATIONS

Functions: Stop, Tail, Direction Indicator
Operating Voltage: 10-30V DC
Consumption: Stop: 4W Tail: 0,5W D.I.: 4,6W
Type of protection: IP67

ECE APPROVED

EMC APPROVED

NEW

4-FUNCTION REAR LED LAMP

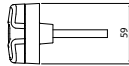
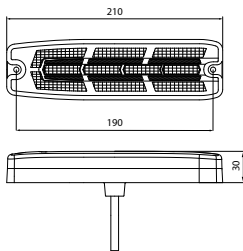

REF. No

DSL-4040

With Cable exit

TECHNICAL SPECIFICATIONS

Functions: Stop, Tail, Direction Indicator, Reverse
Operating Voltage: 10-30V DC
Consumption: Stop: 4W Tail: 0,5W D.I.: 4,6W Rev: 1,7W
Type of protection: IP67

ECE APPROVED

EMC APPROVED

4-FUNCTION REAR LED LAMP

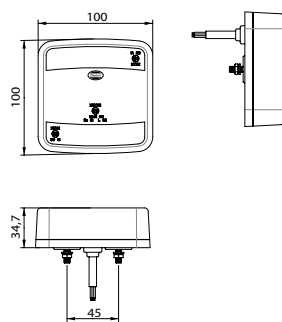

REF. No

DSL-4100

Basic Version

DSL-4100PL

With Number Plate Lamp

TECHNICAL SPECIFICATIONS

Functions: Tail, Stop, Direction Indicator, Reflex Reflector
Optional functions: Number plate lamp
Operating Voltage: 9-33V DC
Consumption: Stop: 0,6/1,2W Tail: 0,5/0,75W D.I.: 0,75/1,5W NPL: 0,5/0,75W
Type of protection: IP67

ECE APPROVED

NEW

4-FUNCTION REAR LED LAMP

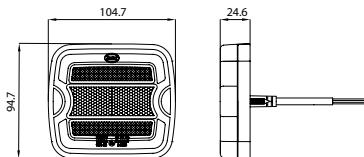

REF. No

DSL-4150

Clear inner lens

DSL-4150PL

Clear inner lens & Number Plate Lamp

DSL-4150.56

Color inner lens

DSL-4150.56PL

Color inner lens & Number Plate Lamp



TECHNICAL SPECIFICATIONS

Functions: Stop, Tail, Direction Indicator, Reflex Reflector
Optional functions: Number Plate
Operating Voltage: 10-30V
Consumption: S: 3,3W T: 2,5W D.I.: 1,9W N.P.: 1,2W
Type of protection: IP67

ECE APPROVED

EMC APPROVED

3-FUNCTION REAR LED LAMP WITH FLAT BASE

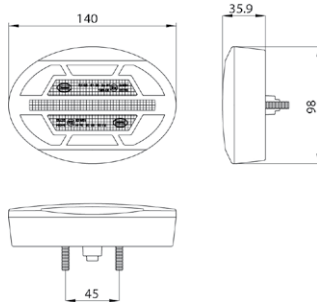

>>>>
Dynamic DI

**Available in
Black Version**

ECE APPROVED

EMC APPROVED

REF. No **DSL-250STD.0**

Add B at the end of the ref. no for black bezel version

TECHNICAL SPECIFICATIONS

Functions: Tail, DI, Stop
Operating Voltage: 10V-30V DC
Consumption: 2W (tail), 3,2W (DI), 3,2W (stop)
Type of Protection: IP67
Cable/Connector: 500 mm cable

3-FUNCTION REAR LED LAMP WITH RECESSED BASE

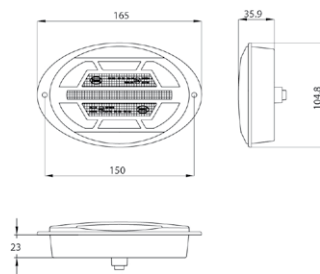

>>>>
Dynamic DI

**Available in
Black Version**

ECE APPROVED

EMC APPROVED

REF. No **DSL-250STD.1**

Add B at the end of the ref. no for black bezel version

TECHNICAL SPECIFICATIONS

Functions: Tail, DI, Stop
Operating Voltage: 10V-30V DC
Consumption: 2W (tail), 3,2W (DI), 3,2W (stop)
Type of Protection: IP67
Cable/Connector: 500 mm cable

3-FUNCTION REAR LED LAMP WITH LATERAL BASE

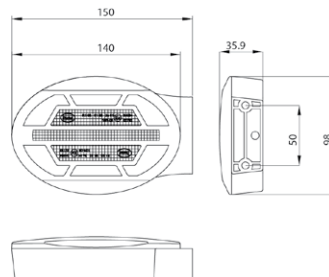

>>>>
Dynamic DI

**Available in
Black Version**

ECE APPROVED

EMC APPROVED

REF. No **DSL-250STD.2**

Add B at the end of the ref. no for black bezel version

TECHNICAL SPECIFICATIONS

Functions: Tail, DI, Stop
Operating Voltage: 10V-30V DC
Consumption: 2W (tail), 3,2W (DI), 3,2W (stop)
Type of Protection: IP67
Cable/Connector: 500 mm cable

3-FUNCTION REAR LED LAMP / DSL-240 SERIES

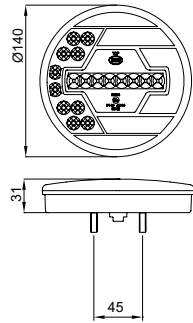

Available in Black Version

ECE APPROVED EMC APPROVED

REF. No
DSL-240FRT-L For surface mounting (LEFT)
DSL-240FRT-R For surface mounting (RIGHT)
 Add B at the end of the ref. no for black bezel version

TECHNICAL SPECIFICATIONS

Functions: Fog, Reversing, Tail
Operating Voltage: 10-30V DC
Consumption: F: 4.3W R: 2W T: 1.7W
Type of Protection: IP67

3-FUNCTION REAR LED LAMP / DSL-240 SERIES

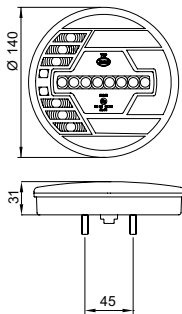

Dynamic DI Available in Black Version

ECE APPROVED EMC APPROVED

REF. No
DSL-240STD-L For surface mounting (LEFT)
DSL-240STD-R For surface mounting (RIGHT)
 Add B at the end of the ref. no for black bezel version

TECHNICAL SPECIFICATIONS

Functions: Stop, Tail, Dynamic D.I.
Operating Voltage: 10-30V DC
Consumption: S: 3W T: 1.7W D.I.: 3.8W
Type of Protection: IP67

3-FUNCTION REAR LED LAMP / DSL-230 SERIES

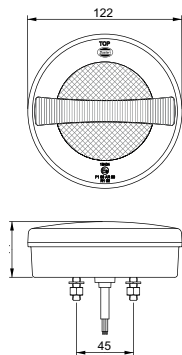

ECE APPROVED EMC APPROVED

REF. No
DSL-230FRT For surface mounting

TECHNICAL SPECIFICATIONS

Functions: Fog, Reversing, Tail
Operating Voltage: 10-30V DC
Consumption: T:1.2W F:4W R:1.5W
Type of Protection: IP67

3-FUNCTION REAR LED LAMP / DSL-230 SERIES

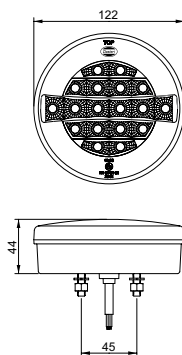

Dynamic DI

ECE APPROVED EMC APPROVED

REF. No
DSL-230STD For surface mounting

TECHNICAL SPECIFICATIONS

Functions: Stop, Tail, Dynamic D.I. (optional)
Operating Voltage: 10-30V DC
Consumption: T: 1.2W S: 1.2W D.I.: 1W
Type of Protection: IP67

REF. No	DYNAMIC D.I.
DSL-230STD	
DSL-D230STDR (R)	●
DSL-D230STDL (L)	●

NOTES: L: LEFT (side) / R: RIGHT (side)

2-FUNCTION REAR LED LAMP / DSL-220 SERIES

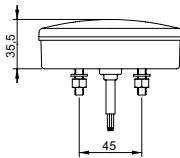
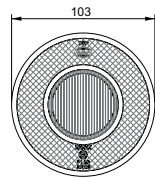

REF. No
DSL-220FR For surface mounting

TECHNICAL SPECIFICATIONS

Functions: Fog, Reversing
Operating Voltage: 10-30V DC
Consumption: F: 3W R: 2W
Type of Protection: IP67

ECE APPROVED

EMC APPROVED

3-FUNCTION REAR LED LAMP / DSL-220 SERIES

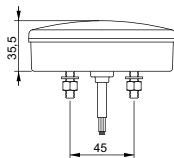
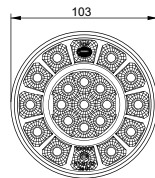

REF. No
DSL-220STD For surface mounting

TECHNICAL SPECIFICATIONS

Functions: Stop, Tail, D.I.
Operating Voltage: 10-30V DC
Consumption: T:0.3W S:1W D.I.:1W
Type of Protection: IP67

ECE APPROVED

4-FUNCTION REAR LED LAMP

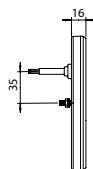
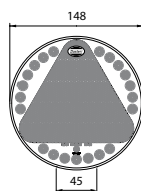
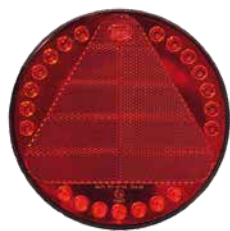

REF. No
D-002STD

TECHNICAL SPECIFICATIONS

Functions: Tail, Stop, Triangle Reflex Reflector, Direction Indicator
Operating Voltage: 9-33V DC
Consumption: (12/24V) Stop: 2/2,7W Tail: 0,75/1,2W D.I.: 1,8/2,4W
Type of protection: IP67

ECE APPROVED

2-FUNCTION REAR LED LAMP

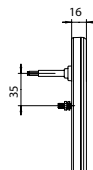
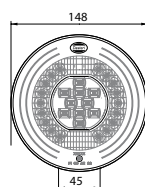

REF. No
D-002FR

TECHNICAL SPECIFICATIONS

Functions: Reversing, Fog
Operating Voltage: 9-33V DC
Consumption: (12/24V) Fog: 2/2,5W Rev.: 0,9/1W
Type of protection: IP67

ECE APPROVED

3-FUNCTION REAR LED LAMP

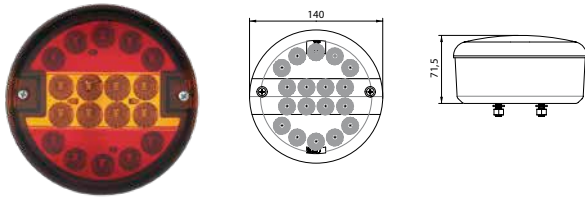

ECE APPROVED EMC APPROVED

REF. No
DSL-8080/18 Red - Amber lens
DSL-8080/18.07 Clear lens

TECHNICAL SPECIFICATIONS

Functions: Tail, Stop, Direction Indicator
Operating Voltage: 9-33V
Consumption: Tail: 1W, Stop: 2W, D.I.: 2W
Type of protection: IP67

2-FUNCTION REAR LED LAMP

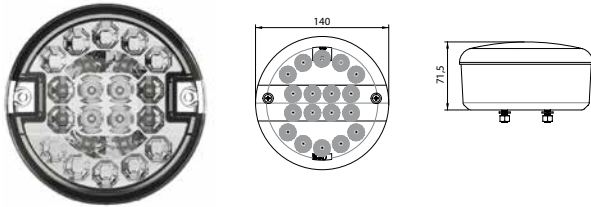

ECE APPROVED

REF. No
DSL-8080/18FR Clear Lens

TECHNICAL SPECIFICATIONS

Functions: Fog, Reverse
Operating Voltage: 9-33V
Consumption: Fog 1W, Rev 1,5W
Type of protection: IP67

3-FUNCTION REAR LED LAMP / DSL-182 SERIES

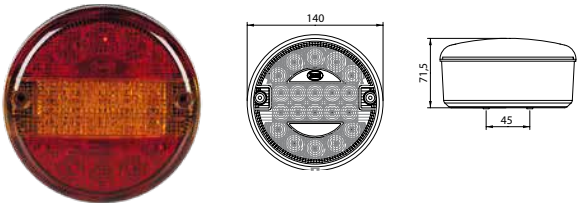

ECE APPROVED

REF. No
DSL-182AR Red - Amber lens

TECHNICAL SPECIFICATIONS

Functions: Tail, Stop, Direction Indicator
Operating Voltage: 9-33V
Consumption: (12/24V) Stop: 0,3/0,4W Tail: 1,7/1,8W
 D.I.: 1,5/1,7W
Type of protection: IP67

2-FUNCTION REAR LED LAMP / DSL-182 SERIES

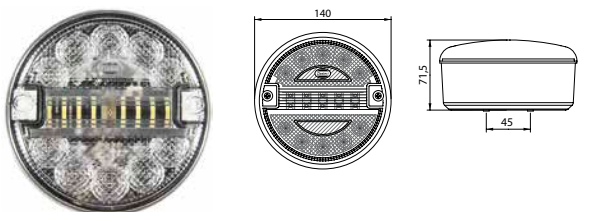

ECE APPROVED

REF. No
DSL-182FRB With housing

TECHNICAL SPECIFICATIONS

Functions: Fog, Reverse
Operating Voltage: 9-33V DC
Consumption: Fog 3W, Rev 2,3W
Type of protection: IP67

2-FUNCTION REAR LED LAMP / DSL-182 SERIES

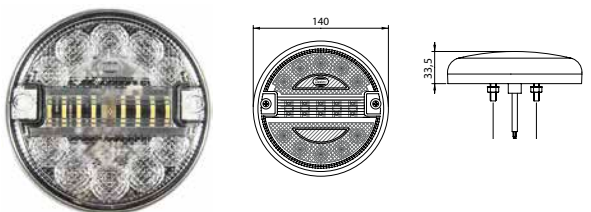

ECE APPROVED

REF. No
DSL-182FR With slim fixed base and fitting screws

TECHNICAL SPECIFICATIONS

Functions: Fog, Reverse
Operating Voltage: 9-33V DC
Consumption: Fog 3W, Rev 2,3W
Type of protection: IP67

4-FUNCTION REAR LED LAMP

TECHNICAL SPECIFICATIONS

Functions: Tail, Stop, Direction Indicator
Operating Voltage: 9-33V
Consumption: Stop:3W Tail: 2W D.I.: 2W
Type of Protection: IP67



ECE APPROVED

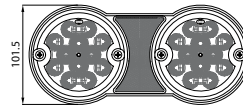
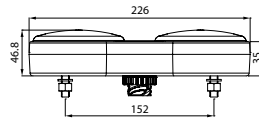

REF. No	PG PLUG	ROUND PLUG (AMP)
DSL-210STDRR (R)	●	
DSL-211STDRR (L)	●	
DSL-212STDRR (R)		●
DSL-210STDRV (R) vertical mounting	●	
DSL-211STDRV (L) vertical mounting	●	
DSL-213STDRR (L)		●
DSL-212STDRV (R) vertical mounting		●
DSL-213STDRV (L) vertical mounting		●

NOTES: L: LEFT (side) / R: RIGHT (side)
 U.K. VERSIONS AVAILABLE FOR ALL TYPES

2-FUNCTION REAR LED LAMP

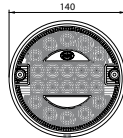

ECE APPROVED

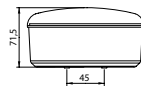

REF. No
DSL-31022R

TECHNICAL SPECIFICATIONS

Functions: Tail, Stop
Operating Voltage: 9-33V
Consumption: Stop: 0,5W Tail: 3W
Type of protection: IP67

3-FUNCTION REAR LED LAMP

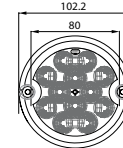

ECE APPROVED

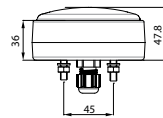

REF. No
DSL-210STDLB With Base / Pg Plug / 1M Cable

TECHNICAL SPECIFICATIONS

Functions: Tail, Stop, Direction Indicator
Operating Voltage: 9-33V DC
Consumption: (12/24V) Stop: 3/4W Tail: 1/1W D.I.: 3/4W
Type of protection: IP67

3-FUNCTION REAR LED LAMP

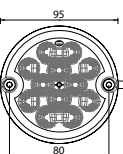

ECE APPROVED

EMC APPROVED



REF. No
DSL-210STDL For surface mounting

TECHNICAL SPECIFICATIONS

Functions: Tail, Stop, Direction Indicator
Operating Voltage: 9-33V DC
Consumption: (12/24V) Stop: 3/4W Tail: 1/1W D.I.: 3/4W
Type of protection: IP67

2-FUNCTION REAR LED LAMP

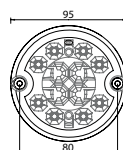

ECE APPROVED

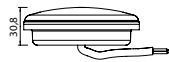

REF. No
DSL-210FR For surface mounting

TECHNICAL SPECIFICATIONS

Functions: Fog, Reverse
Operating Voltage: 9-33V DC
Consumption: Fog 2,6W, Rev 1W
Type of protection: IP67

2-FUNCTION REAR LED LAMP

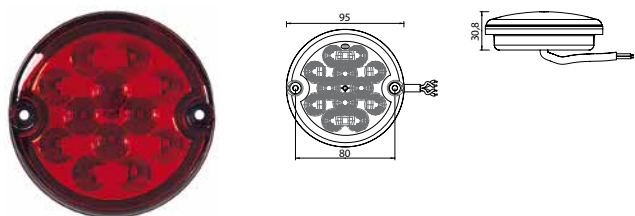

ECE APPROVED SAE DOT APPROVED

REF. No
DSL-210STL For surface mounting

TECHNICAL SPECIFICATIONS

Functions: Tail, Stop
Operating Voltage: 9-33V DC
Consumption: Stop: 3W Tail: 1W
Type of protection: IP67

3-FUNCTION REAR LED LAMP

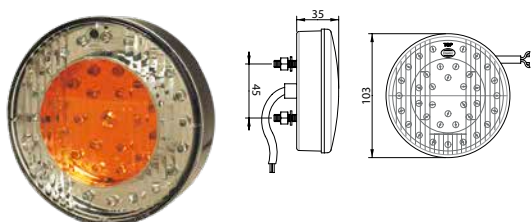

ECE APPROVED

REF. No		REF. No	
DSL-22/12	12 Volt	DSL-22N/12	12 volt, without inner amber lens
DSL-22/24	24 Volt	DSL-22N/24	24 volt, without inner amber lens

TECHNICAL SPECIFICATIONS

Functions: Stop, Tail, Direction Indicator
Operating Voltage: 12 or 24V DC
Consumption: (12/24) Tail: 0,3/0,3W Stop: 2/2W D.I.: 1,5/1,5W
Type of protection: IP67

2-FUNCTION REAR LED LAMP

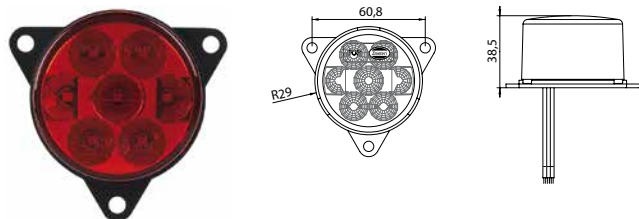

ECE APPROVED

REF. No
DSL0400STL

TECHNICAL SPECIFICATIONS

Functions: Stop, Tail
Operating Voltage: 9-33V DC
Consumption: Stop: 2W Tail: 1W
Type of protection: IP67

2-FUNCTION REAR LED LAMP

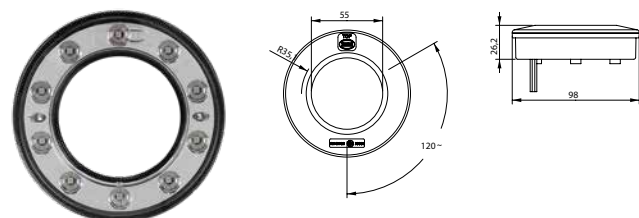

ECE APPROVED

REF. No
DSLR400STL

TECHNICAL SPECIFICATIONS

Functions: Stop, Tail
Operating Voltage: 9-33V DC
Consumption: (12/24V) Stop: 2/2W Tail: 1/1W
Type of protection: IP67

1-FUNCTION REAR LED

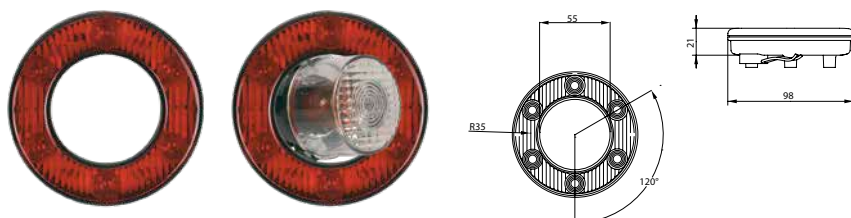

REF. No
DSL-3090

TECHNICAL SPECIFICATIONS

Functions: Tail
Operating Voltage: 9-33V DC
Consumption: Tail: 0,8W
Type of protection: IP67

7-FUNCTION REAR LAMP / 2030 SERIES

TECHNICAL SPECIFICATIONS

Functions: Reversing, Fog, Tail, Reflex Reflector, Stop, Direction Indicator, End Outline Lamp
Optional Functions: Number Plate Lamp, Side Marker Lamp
Operating Voltage: 12V or 24V DC

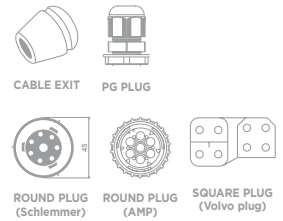
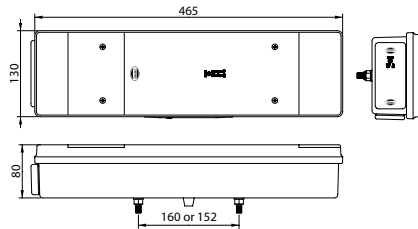

ECE APPROVED

REF. No	SIDE MARKER LAMP (SR)	NUMBER PLATE (PL)	CABLE EXIT	ROUND PLUG (Schlemmer)	SQUARE PLUG (Volvo Plug)	PG PLUG	ROUND PLUG (AMP) for MAN - T-GA	IVECO CONNECTOR	BULBS
R-2030 L-2031			•						4x21W 3x5W
L-2031PL		•	•						4x21W 4x5W
R-2030SR L-2031SR	•		•						4x21W 3x5W
L-2031PLSR	•	•	•						4x21W 4x5W
R-2032 L-2033				•					4x21W 3x5W
L-2033PL		•		•					4x21W 4x5W
R-2032SR L-2033SR	For MAN	•		•					4x21W 3x5W
L-2033PLSR	For MAN	•	•	•					4x21W 4x5W
R-2034 L-2035					•				4x21W 3x5W
L-2035PL		•			•				4x21W 4x5W
R-2034SR L-2035SR	For VOLVO	•			•				4x21W 3x5W
L-2035PLSR	For VOLVO	•	•		•				4x21W 4x5W
R-2030.2 L-2031.2						•			4x21W 3x5W
L-2031.2PL		•				•			4x21W 4x5W
R-2030.2SR L-2031.2SR	•					•			4x21W 3x5W
L-2031.2PLSR	•	•				•			4x21W 4x5W
R-2036SR L-2037SR	For MAN-TG-A	•					ON THE SIDE		4x21W 3x5W
L-2037PLSR	For MAN-TG-A	•	•				ON THE SIDE		4x21W 4x5W
R-2038SR	For IVECO	•						•	4x21W 3x5W
L-2039PLSR	For IVECO	•	•					•	4x21W 4x5W

NOTES: L: LEFT (side) / R: RIGHT (side)

SPARE LENS AVAILABLE REF. NO P-2030 / U.K. VERSIONS AVAILABLE FOR ALL TYPES

7-FUNCTION REAR LAMP / 2040 SERIES

TECHNICAL SPECIFICATIONS

- Functions:** Reversing, Fog, Double Tail, Reflex Reflector, Stop, Direction Indicator, End Outline Lamp
End Outline LED Lamp
- Optional Functions:** Number Plate Lamp, Side Marker Lamp
- Operating Voltage:** 12V or 24V DC

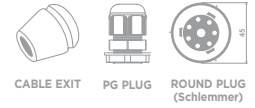
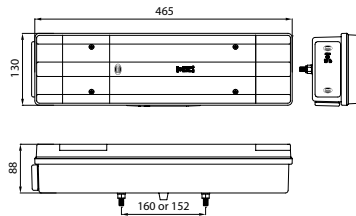

ECE APPROVED

REF. No		SIDE MARKER LAMP (SR)	NUMBER PLATE (PL)	CABLE EXIT	ROUND PLUG (Schlemmer)	PG PLUG	BULBS
R-2040 L-2041				•			4x21W 3x5W
L-2041PL			•	•			4x21W 4x5W
R-2040SR L-2041SR	For MB-SPRINTER	•		•			4x21W 3x5W
L-2041PLSR	For MB-SPRINTER	•	•	•			4x21W 4x5W
R-2042 L-2043	For MB-SPRINTER				•		4x21W 3x5W
L-2043PL			•		•		4x21W 4x5W
R-2042SR L-2043SR	For MB-ATEGO	•			•		4x21W 3x5W
L-2043PLSR	For MB-ATEGO	•	•		•		4x21W 4x5W
R-2040.2 L-2041.2						•	4x21W 3x5W
L-2041.2PL			•			•	4x21W 4x5W
R-2040.2SR L-2041.2SR		•				•	4x21W 3x5W
L-2041.2PLSR		•	•			•	4x21W 4x5W

NOTES: L: LEFT (side) / R: RIGHT (side) SPARE LENS AVAILABLE REF. NO P-2040 / U.K. VERSIONS AVAILABLE FOR ALL TYPES

7-FUNCTION REAR LAMP / 2050 SERIES

TECHNICAL SPECIFICATIONS

Functions: Reversing, Fog, Double Tail, Reflex Reflector, Stop, Direction Indicator, End Outline Lamp
Optional Functions: Number Plate Lamp, Side Marker Lamp
Operating Voltage: 12V or 24V DC

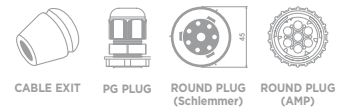
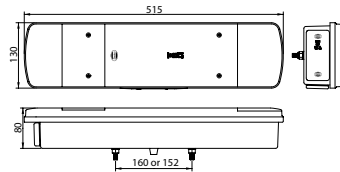

ECE APPROVED

REF. No		SIDE MARKER LAMP (SR)	NUMBER PLATE (PL)	CABLE EXIT	ROUND PLUG (Schlemmer)	ROUND PLUG (AMP ON THE SIDE)	PG PLUG	BULBS
R-2050 L-2051				BACKSIDE CENTER				4x21W 3x5W
L-2051PL			•	BACKSIDE CENTER				4x21W 4x5W
R-2050SR L-2051SR		•		BACKSIDE CENTER				4x21W 3x5W
L-2051PLSR		•	•	BACKSIDE CENTER				4x21W 4x5W
R-2052 L-2053					BACKSIDE CENTER			4x21W 3x5W
L-2053PL			•		BACKSIDE CENTER			4x21W 4x5W
R-2052SR L-2053SR		•			BACKSIDE CENTER			4x21W 3x5W
L-2053PLSR		•	•		BACKSIDE CENTER			4x21W 4x5W
R-2054SR L-2055SR	For VOLVO	•						4x21W 3x5W
L-2055PLSR	For VOLVO	•	•					4x21W 4x5W
R-2054SR.S L-2055SR.S	For SCANIA	•						4x21W 3x5W
R-2054SR162	For SCANIA R	•						4x21W 3x5W
L-2055SR163	For SCANIA R	•						4x21W 4x5W
L-2055PLSR.S	For SCANIA R	•	•					4x21W 4x5W
L-2055PLSR163	For SCANIA R		•					4x21W 4x5W
R-2050.2 L-2051.2							•	4x21W 3x5W
L-2051.2PL			•				•	4x21W 4x5W
R-2050.2SR L-2051.2SR		•					•	4x21W 3x5W
L-2051.2PLSR		•	•				•	4x21W 4x5W
R-2050SR.S L-2051SR.S	For SCANIA	•		BOTTOM SIDE				4x21W 3x5W
L-2051PLSR.S	For SCANIA	•	•	BOTTOM SIDE				4x21W 4x5W

NOTES: L: LEFT (side) / R: RIGHT (side)

SPARE LENS AVAILABLE REF. NO P-2050 / U.K. VERSIONS AVAILABLE FOR ALL TYPES

6-FUNCTION REAR LAMP / 2060 SERIES

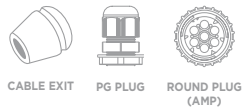
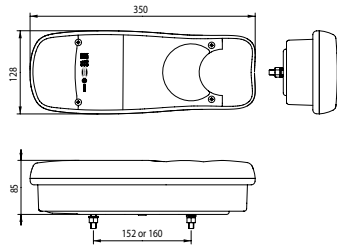

ECE APPROVED

TECHNICAL SPECIFICATIONS

Functions: Reversing, Fog, Double Tail, Reflex Reflector, Stop, Direction Indicator
Optional Functions: Number Plate Lamp
Operating Voltage: 12V or 24V DC

REF. No	NUMBER PLATE (PL)	CABLE EXIT	ROUND PLUG (AMP)	PG PLUG WITH 1m DUAL CABLE	BULBS
R-2060 L-2061		•			4x21W 2x10W
L-2061PL	•	•			4x21W 2x10W
R-2062 L-2063			•		4x21W 2x10W
L-2063PL	•		•		4x21W 2x10W
R-2064 L-2065			•	•	4x21W 2x10W
L-2065PL	•		•	•	4x21W 2x10W

ADD **N** AT THE END OF REFERENCE NUMBER FOR VERSION WITHOUT REFLEX REFLECTOR

NOTES: L: LEFT (side) / R: RIGHT (side)
 * NOT AVAILABLE FOR GERMAN MARKET

SPARE LENS AVAILABLE REF. NO P-2060
 U.K. VERSIONS AVAILABLE FOR ALL TYPES

6-FUNCTION REAR LAMP / 2060D SERIES

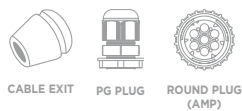
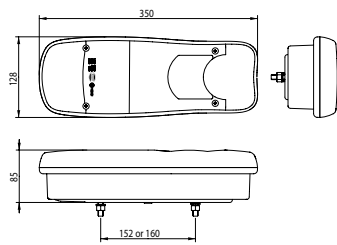

ECE APPROVED

TECHNICAL SPECIFICATIONS

Functions: Stop, Tail, Reversing, Fog, D.I., Reflex Reflector
Optional Functions: Number Plate Lamp
Operating Voltage: 12V or 24V DC

REF. No	NUMBER PLATE (PL)	CABLE EXIT	ROUND PLUG (AMP)	PG PLUG WITH 1m DUAL CABLE	BULBS
R-2060D L-2061D		•			4x21W 2x10W
L-2061DPL	•	•			4x21W 2x10W
R-2062D L-2063D			•		4x21W 2x10W
L-2063DPL	•		•		4x21W 2x10W
R-2064D L-2065D			•	•	4x21W 2x10W
L-2065DPL	•		•	•	4x21W 2x10W

ADD **N** AT THE END OF REFERENCE NUMBER FOR VERSION WITHOUT REFLEX REFLECTOR

NOTES: L: LEFT (side) / R: RIGHT (side)
 * NOT AVAILABLE FOR GERMAN MARKET

SPARE LENS AVAILABLE REF. NO P-2060D
 U.K. VERSIONS AVAILABLE FOR ALL TYPES

6-FUNCTION REAR LAMP / 2070 SERIES

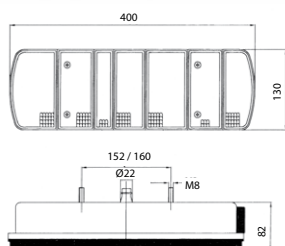

REF. No
R-2070 Right
L-2071 Left
P-2070 Spare Lens

TECHNICAL SPECIFICATIONS

Functions: Fog, Double Tail, Reflex Reflector, Stop, Direction Indicator, Reversing
Operating Voltage: 12V or 24V DC
Consumption: 4x21W / 2x5W

ECE APPROVED

U.K. VERSIONS AVAILABLE FOR ALL TYPES

7-FUNCTION REAR LAMP / 2076 SERIES



REF. No
R-2076SR Right
L-2077SR Left
P-2076 Spare Lens

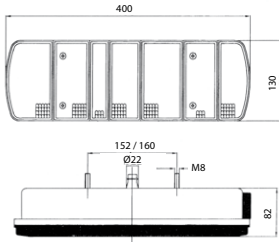

TECHNICAL SPECIFICATIONS

Functions: Reversing, Fog, Double Tail, Reflex Reflector, Stop, Direction Indicator, End Outline, Side Marker Lamp
Operating Voltage: 12V or 24V DC
Consumption: 4x21W / 3x5W

ECE APPROVED U.K. VERSIONS AVAILABLE FOR ALL TYPES

5-FUNCTION REAR LAMP / 2080 SERIES

TECHNICAL SPECIFICATIONS

Functions: Reversing, Fog, Double Tail, Stop, Direction Indicator
Optional Functions: Side Marker Lamp
Operating Voltage: 12V or 24V DC

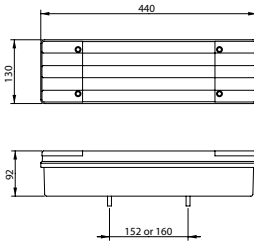

REF. No	CABLE EXIT	ROUND PLUG (AMP)	6 PIN CONNECTOR ON THE HOUSING	BULBS
R-2080 L-2081	●			4x21W 2x5W
R-2082 L-2083		●		4x21W 2x5W
R-2086 L-2087			●	4x21W 2x5W
R-2086SR L-2087SR			●	4x21W 2x5W

NOTES: L: LEFT (side) / R: RIGHT (side)

SPARE LENS AVAILABLE REF. NO P-2080 U.K. VERSIONS AVAILABLE FOR ALL TYPES

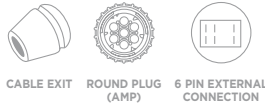

ECE APPROVED

7-FUNCTION REAR LAMP / 2090 SERIES

TECHNICAL SPECIFICATIONS

Functions: Reversing, Fog, Tail, Triangle Reflex Reflector, Stop, Direction Indicator, End Outline Lamp, Side Marker Lamp
Operating Voltage: 12V or 24V DC

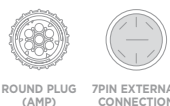
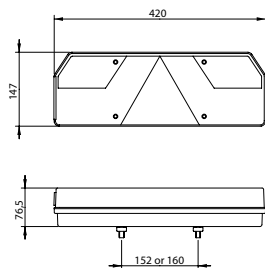

REF. No	CABLE EXIT	PG PLUG	ROUND PLUG (AMP)	7 PIN EXTERNAL CONNECTION	BULBS
R-2090SR	●				1x21/5W 4X21W 3X5W
L-2091SR	●				1x21/5W 4X21W 4X5W
R-2090.2SR		●			1x21/5W 4X21W 3X5W
L-2091.2SR		●			1x21/5W 4X21W 4X5W
R-2090.2SRC3		With 3m cable			1x21/5W 4X21W 3X5W
L-2091.2SRC3		With 3m cable			1x21/5W 4X21W 4X5W
R-2092SR			●		1x21/5W 4X21W 3X5W
L-2093SR			●		1x21/5W 4X21W 4X5W
R-2094SR				●	1x21/5W 4X21W 3X5W
L-2095SR				●	1x21/5W 4X21W 4X5W

NOTES: L: LEFT (side) / R: RIGHT (side)

SPARE LENS AVAILABLE REF. NO P-2090SR (Right), REF. NO P-2091SR (Left) / U.K. VERSIONS AVAILABLE FOR ALL TYPES

ECE APPROVED

7-FUNCTION REAR LAMP / 2100 SERIES

TECHNICAL SPECIFICATIONS

Functions: Reversing, Fog, Tail, Reflex Reflector, Stop, Direction Indicator, End Outline Lamp
Optional Functions: Number Plate Lamp, Side Marker Lamp
Operating Voltage: 12V or 24V DC

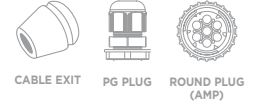
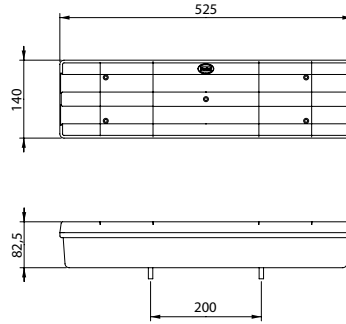

ECE APPROVED

REF. No	SIDE MARKER LAMP (SR)	NUMBER PLATE (PL)	CABLE EXIT	PG PLUG	ROUND PLUG (AMP) ON THE SIDE	6 PIN EXTERNAL CONNENCTOR WITH 1.25m CABLE	BULBS
R-2100 L-2101			•				4x21W 2x10W
L-2101PL		•	•				4x21W 3x10W
R-2100SR L-2101SR	•		•				4x21W 2x10W
L-2101PLSR	•	•	•				4x21W 3x10W
R-2100.2 L-2101.2				•			4x21W 2x10W
L-2101.2PL		•		•			4x21W 3x10W
R-2100.2SR L-2101.2SR	•			•			4x21W 2x10W
L-2101.2PLSR	•	•		•			4x21W 3x10W
R-2102 L-2103					•		4x21W 2x10W
L-2103PL		•			•		4x21W 3x10W
R-2102SR L-2103SR	For MB-ACTROS	•			•		4x21W 2x10W
L-2103PLSR	For MB-ACTROS	•	•		•		4x21W 3x10W
R-2106SR	For NEW MB-ACTROS	•			6 PIN		4x21W 3x10W
L-2107PLSR	For NEW MB-ACTROS	•	•		7 PIN		4x21W 2x10W
R-2104SR	For MB-SK	•				•	4x21W 2x10W
L-2105SR	For MB-SK	•				•	4x21W 2x10W
L-2105PLSR	For MB-SK	•	•			•	4x21W 3x10W

NOTES: L: LEFT (side) / R: RIGHT (side)

SPARE LENS AVAILABLE REF. NO P-2100R (Right) REF. NO P-2100L (Left)
 U.K. VERSIONS AVAILABLE FOR ALL TYPES

6-FUNCTION REAR LAMP / 2110 SERIES

TECHNICAL SPECIFICATIONS

Functions: Reversing, Fog, Double Tail, Reflex Reflector or Triangle Reflex Reflector, Stop, Direction Indicator
Optional Functions: LED Side Marker Lamp (620)
Operating Voltage: 12V or 24V DC

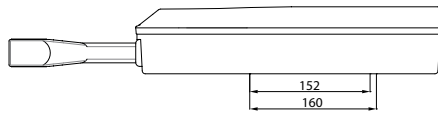
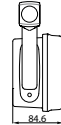
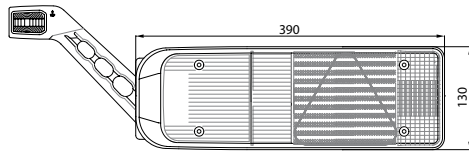

ECE APPROVED

REF. No	REFLEX REFLECTOR	TRIANGLE REFLEX REFLECTOR	STOP	FLASHER	SIDE MARKER LED LAMP	MARKER LAMP WITH RUBBER BASE	ROUND PLUG (AMP)	BULBS
R-2112	•		•	•			•	3x21W 1xPY21W 2x5W
L-2113	•		•	•			•	3x21W 1xPY21W 2x5W
R-2112SR	•		•	•	•		•	3x21W 1xPY21W 2x5W
L-2113SR	•		•	•	•		•	3x21W 1xPY21W 2x5W
R-2112TRSR		•	•	•	•		•	3x21W 1xPY21W 2x5W
L-2113TRSR		•	•	•	•		•	3x21W 1xPY21W 2x5W
R-2112TR		•	•	•			•	3x21W 1xPY21W 2x5W
L-2113TR		•	•	•			•	3x21W 1xPY21W 2x5W
R-2112TR620		•	•	•		•	•	3x21W 1xPY21W 2x5W
L-2113TR620		•	•	•		•	•	3x21W 1xPY21W 2x5W

NOTES: L: LEFT (side) / R: RIGHT (side)

SPARE LENS AVAILABLE REF. NO P-2110, P-2110TR, P-2111TR
 U.K. VERSIONS AVAILABLE FOR ALL TYPES

5-FUNCTION REAR LAMP / 2000 SERIES

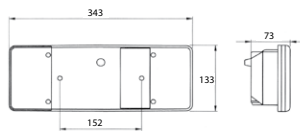

ECE APPROVED

REF. No			
R-2000	Right	P-2000	Spare Lens
L-2001	Left		
L-2001PL	Left with NPL		

TECHNICAL SPECIFICATIONS

Functions:	Reversing, Fog, Tail, Stop, Direction Indicator
Optional:	Number Plate Lamp
Operating Voltage:	12 or 24V DC
Consumption:	2x10W / 4x21W

6-FUNCTION REAR LAMP

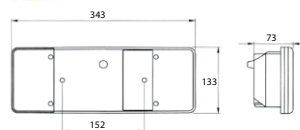

ECE APPROVED

REF. No			
R-2000.110	Right	P-2000.110	Spare Lens
L-2001.110	Left		
L-2001.110PL	Left with NPL		

TECHNICAL SPECIFICATIONS

Functions:	Reversing, Fog, Tail, Reflex Reflector, Stop, Direction Indicator
Optional:	Number Plate Lamp
Operating Voltage:	12 or 24V DC
Consumption:	2x10W / 4x21W

3-FUNCTION REAR LAMP

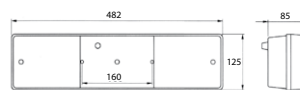

ECE APPROVED

REF. No			
R-2010	Right	P-2010	Spare Lens
L-2011	Left with NPL		

TECHNICAL SPECIFICATIONS

Functions:	Tail, Stop, Direction Indicator
Optional:	Number Plate Lamp
Operating Voltage:	12 or 24V DC
Consumption:	2x5W / 2x21W

4-FUNCTION REAR LAMP

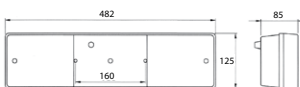

ECE APPROVED

REF. No			
R-2012	Right	P-2012	Spare Lens
L-2013	Left with NPL		

TECHNICAL SPECIFICATIONS

Functions:	Reversing, Stop Tail, Direction Indicator
Optional:	Number Plate Lamp
Operating Voltage:	12 or 24V DC
Consumption:	2x10W / 4x21W

5-FUNCTION REAR LAMP

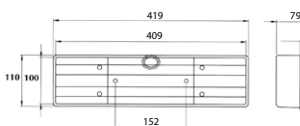

ECE APPROVED

REF. No			
R-2021R	Right with Reverse	P-2021R	Spare lens Right
L-2020F	Left with fog	P-2020F	Spare Lens Left
L-2020FPL	Left with NPL		

TECHNICAL SPECIFICATIONS

Functions:	Reversing (Right), Fog (Left), Stop, Tail, Direction Indicator, Reflex Reflector
Optional:	Number Plate Lamp
Operating Voltage:	12 or 24V DC
Consumption:	1x10W / 3x21W

6-FUNCTION REAR LAMP / 4200 SERIES

TECHNICAL SPECIFICATIONS

Functions: Reversing, Fog, Stop, Tail, Triangle Reflex Reflector, Direction Indicator
Optional Functions: Number Plate Lamp
Operating Voltage: 12 or 24V DC

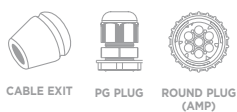
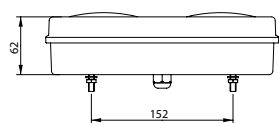
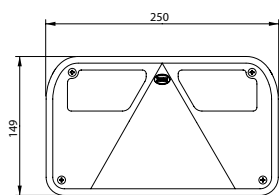

ECE APPROVED

REF. No	NUMBER PLATE	CABLE EXIT	PG PLUG	ROUND PLUG (AMP)	BULBS
R-4200		●			1x21/5W 3x21W
L-4201		●			1x21/5W 3x21W
L-4201PL	●	●			1x21/5W 3x21W 1x4W
R-4202			●		1x21/5W 3x21W
L-4203			●		1x21/5W 3x21W
L-4203PL	●		●		1x21/5W 3x21W 1x4W
R-4204				●	1x21/5W 3x21W
L-4205				●	1x21/5W 3x21W
L-4205PL	●			●	1x21/5W 3x21W 1x4W

NOTES: L: LEFT (side) / R: RIGHT (side) / SPARE LENS AVAILABLE REF. NO P-4200 (Right) / REF. NO P-4201 (Left) U.K. VERSIONS AVAILABLE FOR ALL TYPES

5-FUNCTION REAR LAMP / 4300 SERIES

TECHNICAL SPECIFICATIONS

Functions: Reversing (Right), Fog (Left), Tail, Reflex Reflector, Stop, Direction Indicator
Operating Voltage: 12 or 24V DC

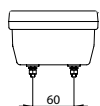
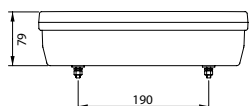
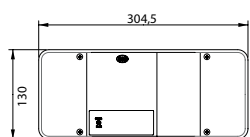

ECE APPROVED

REF. No	REVERSING LAMP	REAR FOG	CABLE EXIT	ROUND PLUG (AMP)	5 PIN EXTERNAL CONNECTOR	BULBS
R-4300	●		●			3x21W 2x5W
L-4301		●	●			3x21W 2x5W
R-4302	●			●		3x21W 2x5W
L-4303		●		●		3x21W 2x5W
R-4306	●				●	3x21W 2x5W
L-4307		●			●	3x21W 2x5W

NOTES: L: LEFT (side) / R: RIGHT (side)

SPARE LENS AVAILABLE REF. NO P-4300 / REF. NO P-4301 U.K. VERSIONS AVAILABLE FOR ALL TYPES

6-FUNCTION REAR LAMP / 4350 SERIES

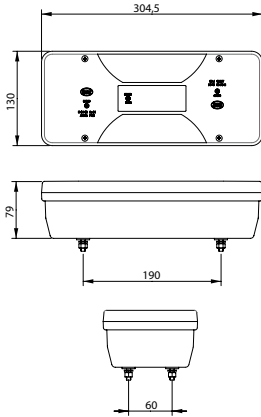

TECHNICAL SPECIFICATIONS

Functions: Reversing, Fog, Tail, Reflex Reflector, Stop, Direction Indicator
Operating Voltage: 12 or 24V DC

REF. No	CABLE EXIT	ROUND PLUG (AMP)	5 PIN EXTERNAL CONNECTOR	BULBS
R-4350	●			2xP21W 1xP21/5W 1xPY21W
L-4351	●			2xP21W 1xP21/5W 1xPY21W
R-4352		●		2xP21W 1xP21/5W 1xPY21W
L-4353		●		2xP21W 1xP21/5W 1xPY21W
R-4356			●	2xP21W 1xP21/5W 1xPY21W
L-4357			●	2xP21W 1xP21/5W 1xPY21W

NOTES: L: LEFT (side) / R: RIGHT (side)

SPARE LENS AVAILABLE REF. NO P-4350

ECE APPROVED

3-FUNCTION REAR LAMP

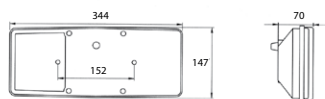

REF. No
8060/5 Left with NPL
8060/6 Right
P-8060-5 Spare Lens

TECHNICAL SPECIFICATIONS

Functions: Stop, Tail, Direction Indicator
Operating Voltage: 12 or 24V DC
Consumption: 1x10W / 2x21W

ECE APPROVED

3-FUNCTION REAR LAMP

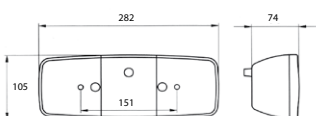

REF. No
8060/1 Left with NPL
8060/2 Right
P-8060-1 Spare Lens

TECHNICAL SPECIFICATIONS

Functions: Stop, Tail, Direction Indicator
Operating Voltage: 12 or 24V DC
Consumption: 1x10W / 2x21W
Type of protection: IP67

ECE APPROVED

3-FUNCTION REAR LAMP

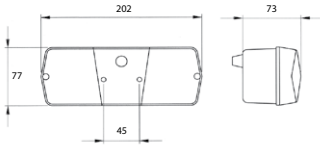
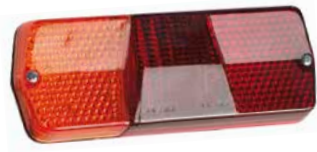

REF. No

8060/3L Left with NPL

P-8060-4L

Spare Lens Left

8060/4L Left

P-8060-4R

Spare Lens Right

8060/4R Right

TECHNICAL SPECIFICATIONS

Functions: Stop, Tail, Direction Indicator

Operating Voltage: 12 or 24V DC

Consumption: 1x10W / 2x21W

3-FUNCTION REAR LAMP

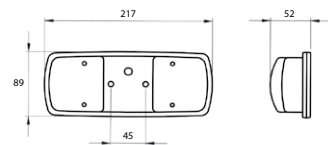

REF. No

8060/8LR Left / Right

P-8060-8

Spare Lens

8060/8PL Left with NPL

TECHNICAL SPECIFICATIONS

Functions: Stop, Tail, Direction Indicator

Operating Voltage: 12 or 24V DC

Consumption: 1x10W / 2x21W

4-FUNCTION REAR LAMP

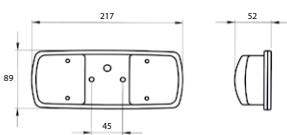

REF. No

8060/9LR Left / Right

P-8060-9

Spare Lens

8060/9PL Left with NPL

TECHNICAL SPECIFICATIONS

Functions: Reversing, Stop, Tail, Direction Indicator

Operating Voltage: 12 or 24V DC

Consumption: 1x10W / 3x21W

4-FUNCTION REAR LAMP

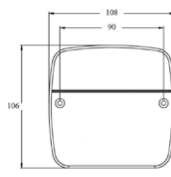

ECE APPROVED



REF. No

4100 Rear Mounting with NPL

P-4100 Spare Lens

TECHNICAL SPECIFICATIONS

Functions: Stop, Tail, Direction Indicator, Number Plate Lamp

Operating Voltage: 12 or 24V DC

Consumption: 2x21W / 1x5W

4-FUNCTION REAR LAMP

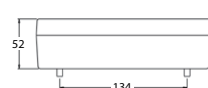

REF. No

4000 Rear Mounting

P-4000

Spare Lens

TECHNICAL SPECIFICATIONS

Functions: Reversing, Stop, Tail, Direction Indicator, Number Plate Lamp

Operating Voltage: 12 or 24V DC

Consumption: 1x21W / 1x21/5W

ECE APPROVED

3-FUNCTION REAR LAMP

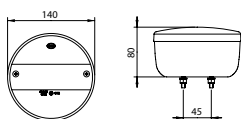

REF. No
8080/17 With NPL
8080/18 Without NPL
P-8080-18 Spare Lens

TECHNICAL SPECIFICATIONS

Functions: Stop, Tail, Direction Indicator
Operating Voltage: 12 or 24V DC
Consumption: 2x21W / 1x5W

ECE APPROVED

3-FUNCTION REAR LAMP

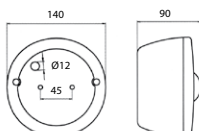

REF. No
8080/15 With NPL
8080/16 Without NPL
P-8080-16 Spare Lens

TECHNICAL SPECIFICATIONS

Functions: Stop, Tail, Direction Indicator
Operating Voltage: 12 or 24V DC
Consumption: 2x21W / 1x5W

3-FUNCTION REAR LAMP

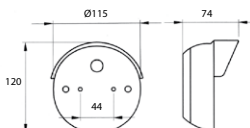

REF. No
8080/12 With Protective Cap
P-8080-12 Spare Lens

TECHNICAL SPECIFICATIONS

Functions: Stop, Tail, Direction Indicator
Operating Voltage: 12 or 24V DC
Consumption: 2x18W / 1x5W

3-FUNCTION REAR LAMP

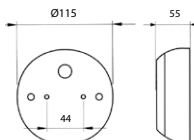

REF. No
8080/14 Without Protective Cap
P-8080-12 Spare Lens

TECHNICAL SPECIFICATIONS

Functions: Stop, Tail, Direction Indicator
Operating Voltage: 12 or 24V DC
Consumption: 2x18W / 1x5W

1-FUNCTION REAR LAMP

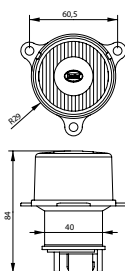

REF. No
1070-M122 Rear Mounting

TECHNICAL SPECIFICATIONS

Functions: Tail
Operating Voltage: 12 or 24V DC
Consumption: 1x5W

ECE APPROVED

3-FUNCTION REAR LAMP

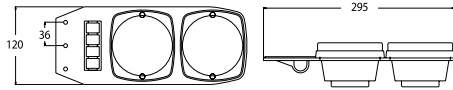

REF. No
145/52.065 Rear Mounting

TECHNICAL SPECIFICATIONS

Functions: Stop, Tail, Direction Indicator
Operating Voltage: 12 or 24V DC
Consumption: 1x21W/5W, 1x21W

ECE APPROVED

5-FUNCTION REAR LAMP

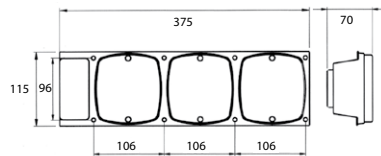

REF. No
140/52 Rear Mounting

TECHNICAL SPECIFICATIONS

Functions: Stop, Tail, D. I., Reversing, Reflex Reflector
Operating Voltage: 12 or 24V DC
Consumption: 1x21W/5W, 2x21W

ECE APPROVED

3-FUNCTION REAR LAMP

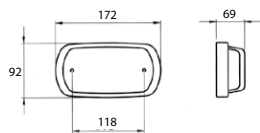

REF. No
8060/45 With Black Rim
8060/45N With Chrome-type Rim
P-8060-45 Spare Lens

TECHNICAL SPECIFICATIONS

Functions: Stop, Tail, Direction Indicator
Operating Voltage: 12 or 24V DC
Consumption: 2x15W / 1x5W

3-FUNCTION REAR LAMP

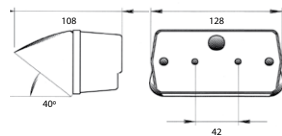

REF. No
8080/20R Right with red base
8080/20L Left with red base

REF. No
P-8080/20R Spare Lens Right
P-8080/20L Spare Lens Left

TECHNICAL SPECIFICATIONS

Functions: Stop, Tail, Direction Indicator
Operating Voltage: 12 or 24V DC
Consumption: 2x18W / 1x5W

3-FUNCTION REAR LAMP

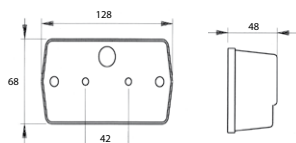

REF. No
8080/19R Right with rear mounting
8080/19L Left with rear mounting

REF. No
P-8080/20R Spare Lens Right
P-8080/20L Spare Lens Left

TECHNICAL SPECIFICATIONS

Functions: Stop, Tail, Direction Indicator
Operating Voltage: 12 or 24V DC
Consumption: 1x21W / 1x21/5W

3-FUNCTION REAR LAMP

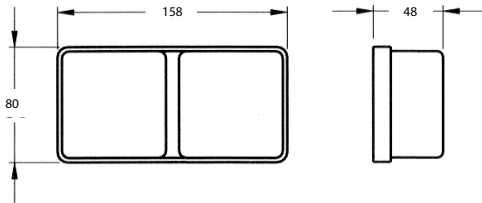
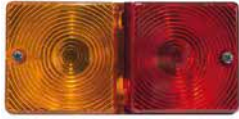

REF. No
8080/7T Rear Mounting
P-8080-70 Spare Lens

TECHNICAL SPECIFICATIONS

Functions: Stop, Tail, Direction Indicator
Operating Voltage: 12 or 24V DC
Consumption: 1x21W, 1x21/5W

3-FUNCTION REAR LAMP

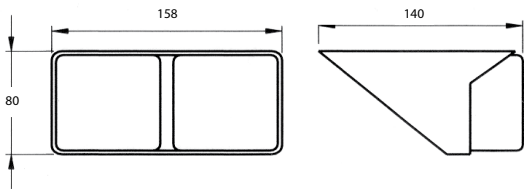

REF. No
8080/70L Left
8080/70R Right
P-8080-70 Spare Lens

TECHNICAL SPECIFICATIONS

Functions: Stop, Tail, Direction Indicator
Operating Voltage: 12 or 24V DC
Consumption: 1x21W, 1x21/5W

3-FUNCTION REAR LAMP

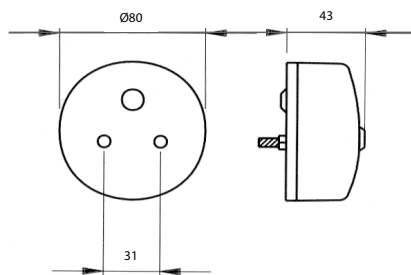

REF. No
8080/21 Rear Mounting
P-8080-21 Spare Lens

TECHNICAL SPECIFICATIONS

Functions: Stop, Tail, Direction Indicator
Operating Voltage: 12 or 24V DC
Consumption: 1x18W, 1x21/5W

2-FUNCTION REAR LAMP

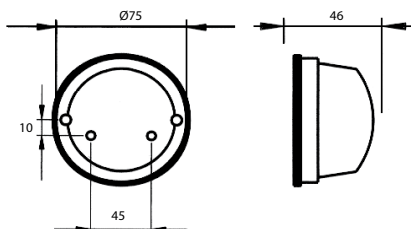

REF. No
8080/23 Rear Mounting
P-8080-23 Spare Lens

TECHNICAL SPECIFICATIONS

Functions: Tail, Direction Indicator
Operating Voltage: 12 or 24V DC
Consumption: 1x5W, 2x18W

1-FUNCTION REAR LAMP

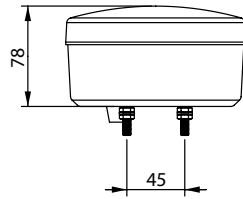
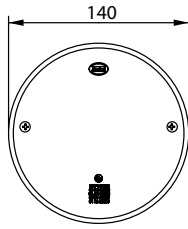

ECE APPROVED

REF. No

3101.06

P-3100.06

Rear Mounting

Spare Lens

TECHNICAL SPECIFICATIONS

Functions: Tail
Operating Voltage: 12 or 24V DC
Consumption: 1x5W

1-FUNCTION REAR LAMP

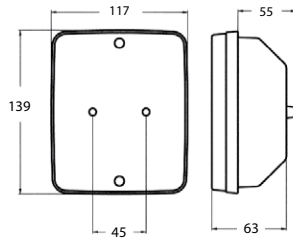

ECE APPROVED

REF. No

3001.06

P-3000.06

Rear Mounting

Spare Lens

TECHNICAL SPECIFICATIONS

Functions: Tail
Operating Voltage: 12 or 24V DC
Consumption: 1x5W

1-FUNCTION REAR LAMP

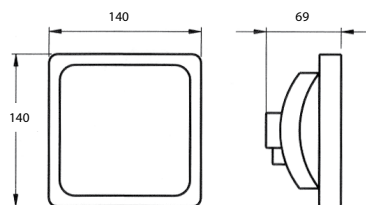

REF. No

8060/46.06

Rear Mounting

TECHNICAL SPECIFICATIONS

Functions: Tail
Operating Voltage: 12 or 24V DC
Consumption: 1x5W



FRONT POSITION LAMPS & DRL





NEW

FRONT LED 2-FUNCTION HEAD LAMP



REF. No

DSL-HBD12

TECHNICAL SPECIFICATIONS

Functions: High Beam, Direction Indicator

Operating Voltage: 10-30V DC

Consumption: H.B.: 18W, D.I.: 6.4W

Type of Protection: IP69

Cable/Connector: 400 mm cable

ECE APPROVED

EMC APPROVED

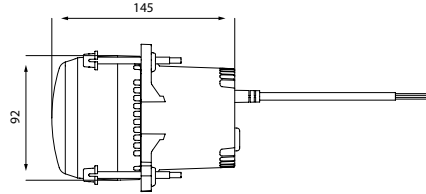
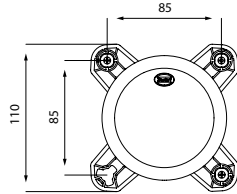

NEW

FRONT LED 3-FUNCTION HEAD LAMP



REF. No

DSL-HB12

TECHNICAL SPECIFICATIONS

Functions: High Beam, Daytime Running Lamp, Front Position

Operating Voltage: 10-30V DC

Consumption: H.B.: 17.4W, D.R.L.: 5.2W, F.P.: 1.1W

Type of Protection: IP69

Cable/Connector: 400 mm cable

SAE APPROVED

ECE APPROVED

EMC APPROVED

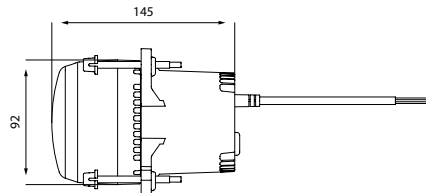
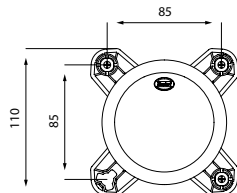

NEW

FRONT LED 3-FUNCTION HEAD LAMP



REF. No

DSL-LB12

TECHNICAL SPECIFICATIONS

Functions: Low Beam, Daytime Running Lamp, Front Position

Operating Voltage: 10-30V DC

Consumption: L.B.: 17.4W, D.R.L.: 5.2W, F.P.: 1.1W

Type of Protection: IP69

Cable/Connector: 400 mm cable

SAE APPROVED

ECE APPROVED

EMC APPROVED

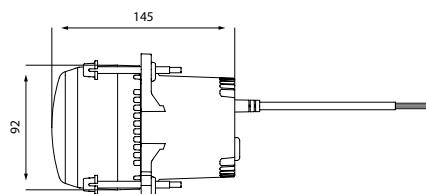
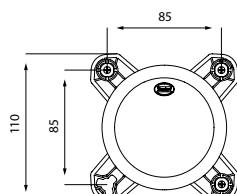

FRONT LED HIGH-LOW BEAM LAMP

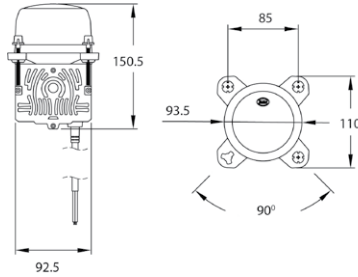

ECE APPROVED

EMC APPROVED

REF. No

DSL-HLB10

TECHNICAL SPECIFICATIONS

Functions: Front Position, Daytime Running Light, High & Low Beam

Operating Voltage: 10-30V DC

Consumption: HB: 30W, LB: 29W, DRL: 5W, F: 0,7W/1W

Type of Protection: IP67

FRONT LED HIGH BEAM LAMP

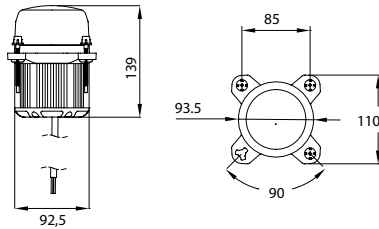

ECE APPROVED

EMC APPROVED

REF. No

DSL-HB10

TECHNICAL SPECIFICATIONS

Functions: High Beam, Front Position, Daytime Running Lamp

Operating Voltage: 10-30V

Consumption: HB: 15W, DRL: 7W, F: 0,5W

Type of Protection: IP67

FRONT LED HIGH BEAM LAMP

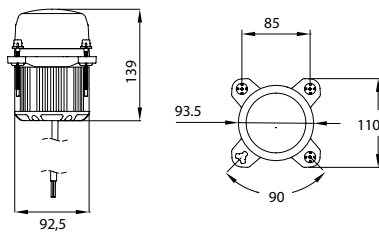

ECE APPROVED

EMC APPROVED

REF. No

DSL-HBD10

TECHNICAL SPECIFICATIONS

Functions: High Beam, Direction Indicator Lamp

Operating Voltage: 10-30V

Consumption: HB: 15W, D.I.: 7W, F: 0.5W

Type of Protection: IP67

FRONT LED LOW BEAM LAMP

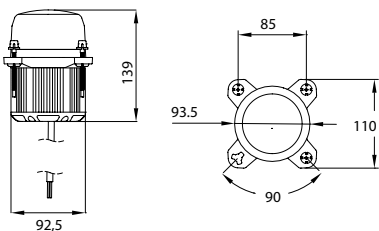

ECE APPROVED

EMC APPROVED

REF. No

DSL-LB10

TECHNICAL SPECIFICATIONS

Functions: Low Beam, Front Position, Daytime Running Light

Operating Voltage: 10-30V

Consumption: LB: 15W, DRL: 7W, F: 0,5W

Type of Protection: IP67

FRONT LED HIGH-LOW BEAM LAMP

TECHNICAL SPECIFICATIONS

Functions: High Beam, Low Beam, Front Position, Front D.I, Side D.I
Operating Voltage: 110V-30V DC
Consumption: HB: 17,3W, LB: 16,1W, FP: 3,5W, D.I: 5,1W, Heated Lens version: HB: 49,7W, LB: 48,6W, FP: 4,2W, D.I: 7W
Type of Protection: IP67

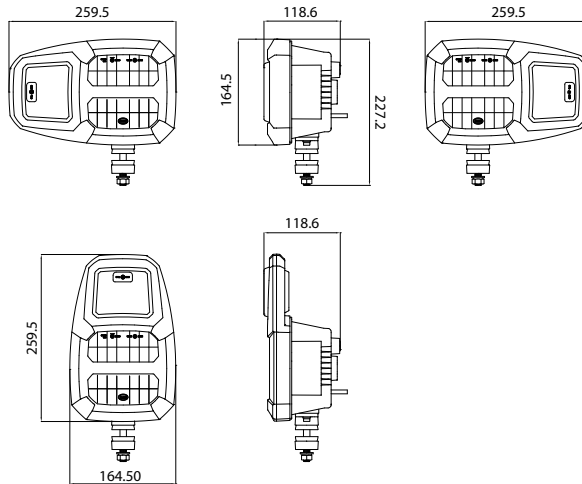

ECE APPROVED

EMC APPROVED

Variants	DI - Amber Lens	DI - Clear Lens	Cable	Deutsch Connector	Heated Lens	Not Heated Lens	Left Hand DI	Right Hand DI	Vertical Placement DI
DSL-HLB20.05.CHT-L	•		•		•		•		
DSL-HLB20.05.CHT-R	•		•		•			•	
DSL-HLB20.05.CHT-V	•		•		•				•
DSL-HLB20.05.DHT-L	•			•	•		•		
DSL-HLB20.05.DHT-R	•			•	•			•	
DSL-HLB20.05.DHT-V	•			•	•				•
DSL-HLB20.05.C-L	•		•			•	•		
DSL-HLB20.05.C-R	•		•			•		•	
DSL-HLB20.05.C-V	•		•			•			•
DSL-HLB20.05.D-L	•			•		•	•		
DSL-HLB20.05.D-R	•			•		•		•	
DSL-HLB20.05.D-V	•			•		•			•
DSL-HLB20.07.CHT-L		•	•		•		•		
DSL-HLB20.07.CHT-R		•	•		•			•	
DSL-HLB20.07.CHT-V		•	•		•				•
DSL-HLB20.07.DHT-L		•		•	•		•		
DSL-HLB20.07.DHT-R		•		•	•			•	
DSL-HLB20.07.DHT-V		•		•	•				•
DSL-HLB20.07.C-L		•	•			•	•		
DSL-HLB20.07.C-R		•	•			•		•	
DSL-HLB20.07.C-V		•	•			•			•
DSL-HLB20.07.D-L		•		•		•	•		
DSL-HLB20.07.D-R		•		•		•		•	
DSL-HLB20.07.D-V		•		•		•			•



FRONT LED HIGH-LOW BEAM LAMP / DSL-HLB25 SERIES

TECHNICAL SPECIFICATIONS

Functions: High Beam, Low Beam
Operating Voltage: 10-30V DC
Consumption: H.B.: 17.3W, L.B.: 16.1W Heated Lens version: H.B.: 49,7W, L.B.: 48,6W
Type of Protection: IP69
Cable/Connector: 300 mm cable, 300 mm with Deutsch Connector

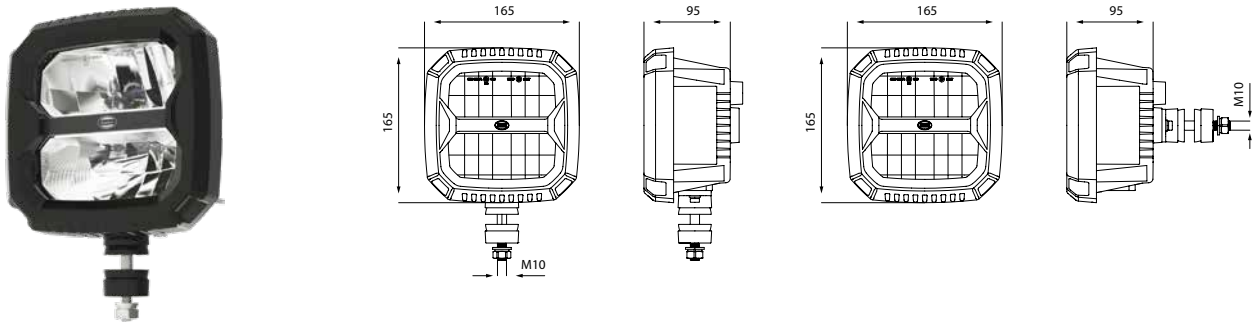

ECE APPROVED

EMC APPROVED

SAE APPROVED

REF. No	Illuminated Logo	Cable Output	Deutsch Connector	Heated Lens
DSL-HLB25.C		•		
DSL-HLB25.01.C	•	•		
DSL-HLB25.D			•	
DSL-HLB25.01.D	•		•	
DSL-HLB25.CHT		•		•
DSL-HLB25.01.CHT	•	•		•
DSL-HLB25.DHT			•	•
DSL-HLB25.01.DHT	•		•	•

FRONT FOG LED LAMP

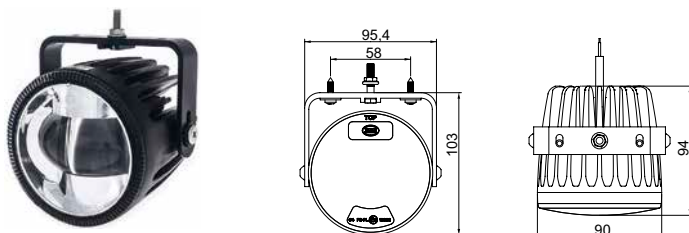

REF. No
DSL-FF10 Front Fog LED Lamp

TECHNICAL SPECIFICATIONS

Operating Voltage: 10-30V DC
Consumption: 12W
Type of Protection: IP67

ECE APPROVED

EMC APPROVED



FRONT LED MULTIFUNCTIONAL LAMP / DSL-250TDF SERIES

TECHNICAL SPECIFICATIONS

- Functions:** Front Position, Front D.I, Reflex Reflector
- Operating Voltage:** 10-30V DC
- Consumption:** D.I.: 5.5W, T.: 2.5W
- Type of Protection:** IP67
- Cable/Connector:** 500 mm cable

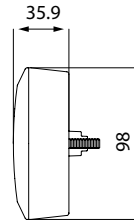
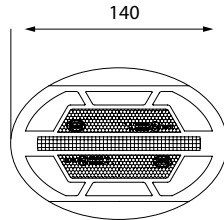
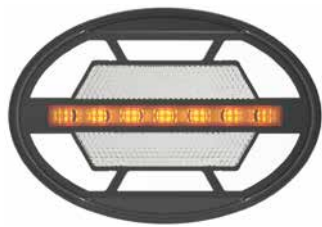

WITH FLAT BASE

REF. No
DSL-250TDF.0

ECE APPROVED

EMC APPROVED

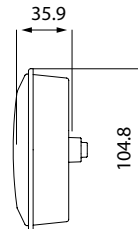
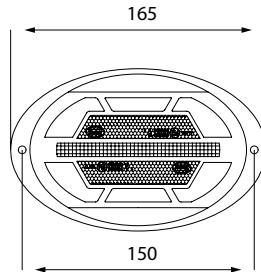
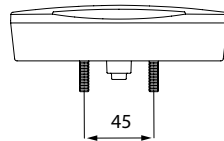

WITH RECESSED BASE

REF. No
DSL-250TDF.1

ECE APPROVED

EMC APPROVED

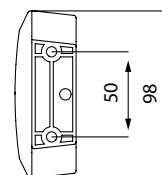
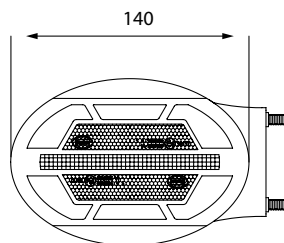
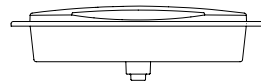

WITH LATERAL BASE

REF. No
DSL-250TDF.2

ECE APPROVED

EMC APPROVED

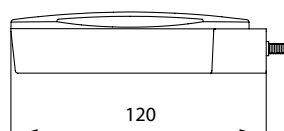

FRONT LED POSITION LAMP

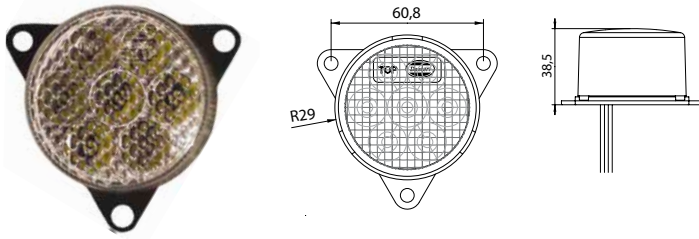

REF. No
DSL0400FT

TECHNICAL SPECIFICATIONS

Functions: Front Position lamp
Operating Voltage: 10-30V DC
Consumption: 0,5W
Type of Protection: IP67

ECE APPROVED EMC APPROVED SAE DOT APPROVED

LED FRONT POSITION LAMP

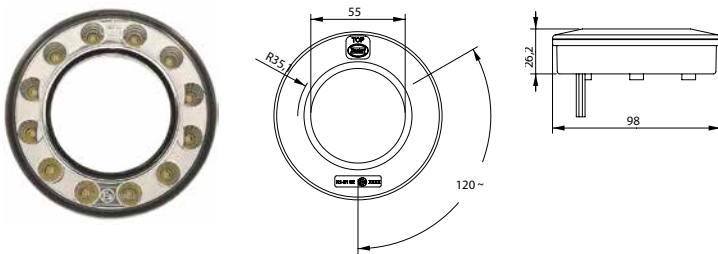

REF. No
DSL400FT Front Position

TECHNICAL SPECIFICATIONS

Operating Voltage: 10-30V DC
Consumption: 0.5W
Type of Protection: IP67

ECE APPROVED

2-FUNCTION LED FRONT LAMP

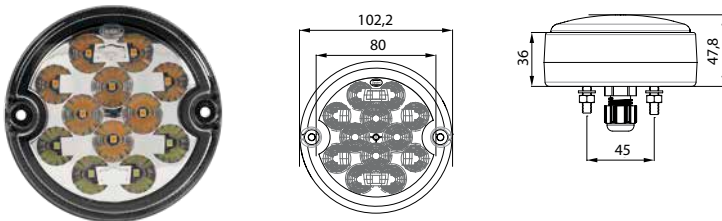

REF. No
DSL-210TDLB With base

TECHNICAL SPECIFICATIONS

Functions: Front Position, Front Direction Indicator
Operating Voltage: 9-33V DC
Consumption: D.l.: 4W F.P.: 1W
Type of Protection: IP67

ECE APPROVED

2-FUNCTION LED FRONT LAMP

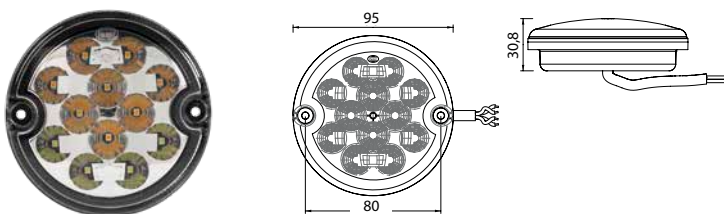

REF. No
DSL-210TDL Without base

TECHNICAL SPECIFICATIONS

Functions: Front Position, Front Direction Indicator
Operating Voltage: 9-33V DC
Consumption: D.l.: 4W F.P.: 1W
Type of Protection: IP67

EMC APPROVED SAE DOT APPROVED

NEW

3-FUNCTION FRONT LED LAMP

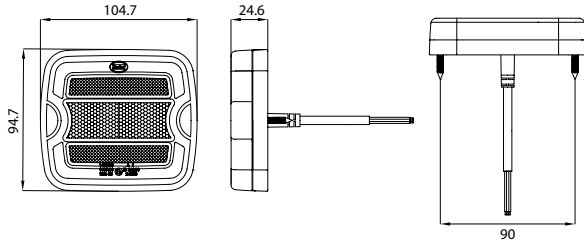

ECE APPROVED

EMC APPROVED

REF. No
DSL-4150F

TECHNICAL SPECIFICATIONS

Functions: Front Position, Direction Indicator, Reflex Reflector
Operating Voltage: 10-30V
Consumption: FP: 1.9W D.I.: 3.5W
Type of Protection: IP67



NEW

LED DAYTIME RUNNING LAMP / DSL-260DRL

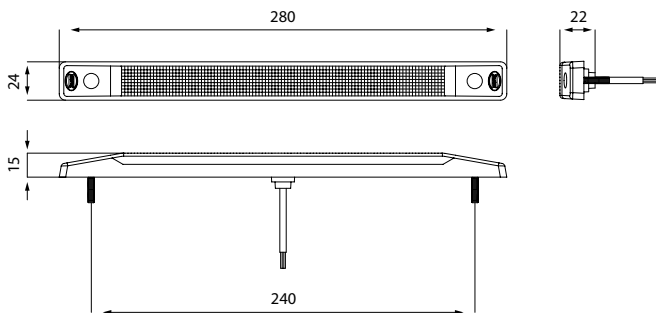

ECE APPROVED

EMC APPROVED

REF. No
DSL-260DRL Clear

TECHNICAL SPECIFICATIONS

Functions: Front Position, Daytime Running Light
Operating Voltage: 10-30V DC
Consumption: FP: 1W, DRL: 5W
Type of Protection: IP67
Cable/Connector: 500 mm cable



LED DAYTIME RUNNING LAMP



REF. No

DRTL-205 with 5 LEDs

DRTL-206 with 6 LEDs

DRTL-207 with 7 LEDs

DRTL-208 with 8 LEDs

TECHNICAL SPECIFICATIONS

Functions: Front Position, Daytime Running light

Operating Voltage: 10-30V DC

Consumption: D.R.: 7W FRONT: 0,7W

Type of Protection: IP67

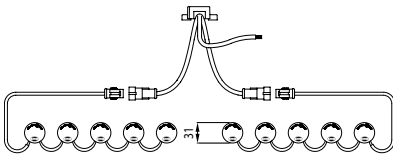

ECE APPROVED

LED DAYTIME RUNNING LAMP



REF. No

DRTL-108

TECHNICAL SPECIFICATIONS

Functions: Front Position, Daytime Running light

Operating Voltage: 10-30V DC

Consumption: D.R.: 3W, Front: 0,5W

Type of Protection: IP67

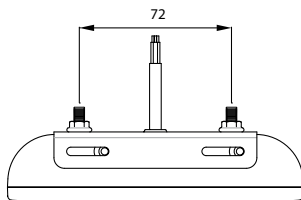
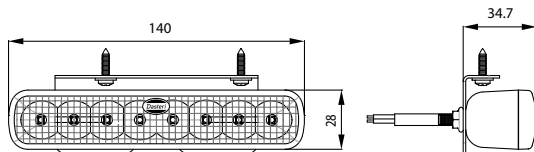

ECE APPROVED

EMC APPROVED

FRONT LED POSITION LAMP

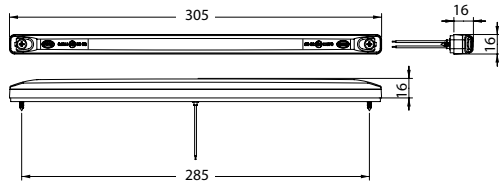

ECE APPROVED

EMC APPROVED

REF. No

DSL-12FT12

Front 12 Volt

DSL-12FT24

Front 24 Volt

TECHNICAL SPECIFICATIONS

Functions: Front Position lamp

Operating Voltage: 12 or 24V DC

Consumption: 0,6W

Type of Protection: IP67

1-FUNCTION FRONT LAMP

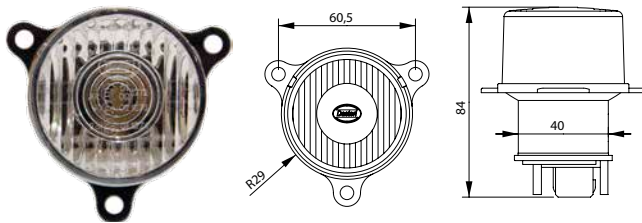

ECE APPROVED

REF. No

1070-M022

TECHNICAL SPECIFICATIONS

Functions: Front Position

Operating Voltage: 12 or 24V DC

Consumption: 1x5W

Type of Protection: IP67

3-FUNCTION FRONT LAMP

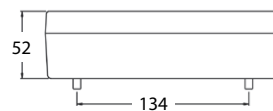
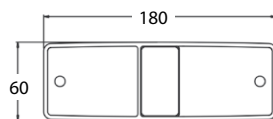

REF. No

4001

Lamp

P-4001

Spare Lens

TECHNICAL SPECIFICATIONS

Functions: Front Position, Direction Indicator, Reflex Reflector

Operating Voltage: 12 or 24V DC

Consumption: 1x21W / 1x5W

2-FUNCTION FRONT LAMP

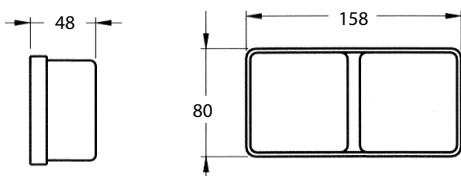

REF. No

8080/7F

Lamp

P-8080-7E

Spare Lens

TECHNICAL SPECIFICATIONS

Functions: Front Position, Direction Indicator

Operating Voltage: 12 or 24V DC

Consumption: 1x21W / 1x5W

2-FUNCTION FRONT LAMP

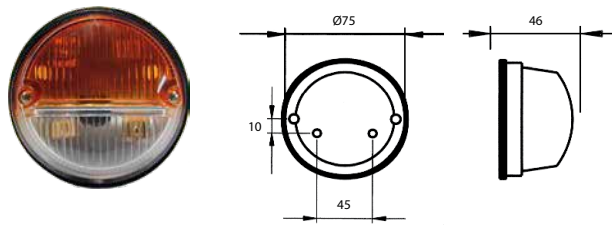

REF. No
8080/24 Lamp
P-8080-24 Spare Lens

TECHNICAL SPECIFICATIONS

Functions: Front Position, Direction Indicator
Operating Voltage: 12 or 24V DC
Consumption: 1x18W / 1x5W

2-FUNCTION FRONT LAMP

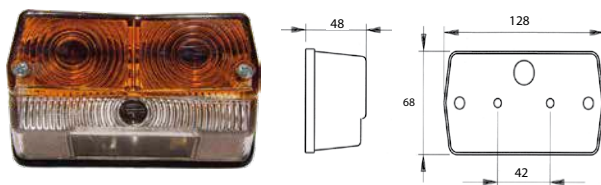

REF. No
8080/19E Lamp
P-8080-20E Spare Lens

TECHNICAL SPECIFICATIONS

Functions: Front Position, Direction Indicator
Operating Voltage: 12 or 24V DC
Consumption: 1x18W / 1x5W

2-FUNCTION FRONT LAMP

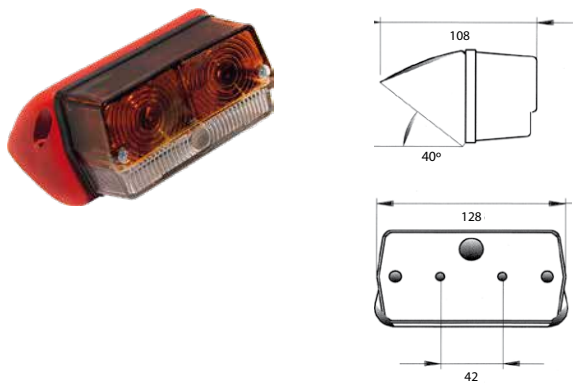

REF. No
8080/20E Lamp with red base
P-8080-20E Spare Lens

TECHNICAL SPECIFICATIONS

Functions: Front Position, Direction Indicator
Operating Voltage: 12 or 24V DC
Consumption: 1x18W / 1x5W

2-FUNCTION FRONT LAMP

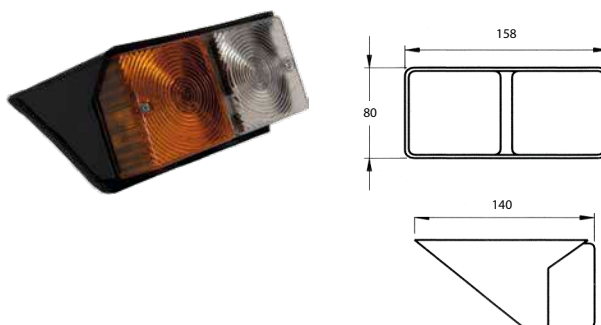

REF. No
8080/7EL Left
8080/7ER Right
P-8080-7E Spare Lens

TECHNICAL SPECIFICATIONS

Functions: Front Position, Direction Indicator
Operating Voltage: 12 or 24V DC
Consumption: 1x21W / 1x5W



DIRECTION INDICATOR LAMPS



LED REAR DIRECTION INDICATOR LAMP



ECE APPROVED

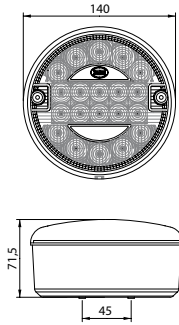

REF. No
DSL-31002A With amber lens

TECHNICAL SPECIFICATIONS

Functions: Direction Indicator
Operating Voltage: 9-33V DC
Consumption: 3W
Type of protection: IP67

LED REAR DIRECTION INDICATOR LAMP



ECE APPROVED

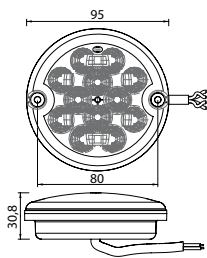

REF. No
DSL-210DIR With amber lens

TECHNICAL SPECIFICATIONS

Functions: Direction Indicator
Operating Voltage: 9-33V DC
Consumption: 2W
Type of protection: IP67

LED FRONT / REAR DIRECTION INDICATOR LAMP / DSL0400 SERIES



ECE APPROVED EMC APPROVED

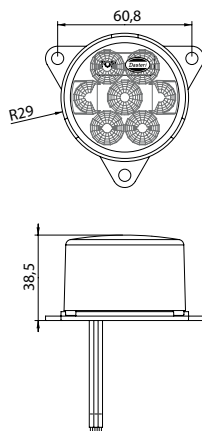

REF. No
DSL0400DIR.05 Rear with amber lens
DSL0400DIF.05 Front with amber lens
DSL0400DIR.07 Rear with clear lens
DSL0400DIF.07 Front with clear lens

TECHNICAL SPECIFICATIONS

Functions: Direction Indicator
Operating Voltage: 9-33V DC
Consumption: 2W
Type of protection: IP67

LED REAR DIRECTION INDICATOR LAMP



ECE APPROVED

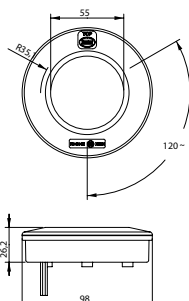

REF. No
DSLR400DIR With clear lens

TECHNICAL SPECIFICATIONS

Functions: Direction Indicator
Operating Voltage: 10-30V DC
Consumption: 2W
Type of protection: IP67

LED SIDE DIRECTION INDICATOR LAMP

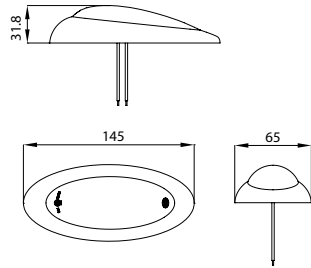

ECE APPROVED EMC APPROVED

REF. No
DSL-035 With amber lens

TECHNICAL SPECIFICATIONS

Functions: Direction Indicator Category 5
Operating Voltage: 10-30V
Consumption: 2W
Type of protection: IP67

LED SIDE DIRECTION INDICATOR LAMP

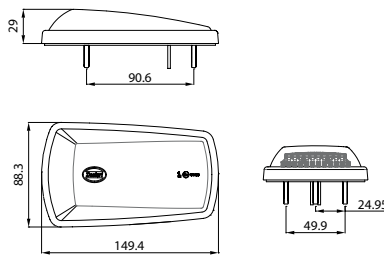

ECE APPROVED EMC APPROVED

REF. No
DSL-036.05 Amber lens, Black base
DSL-036S Smoked Clear lens

TECHNICAL SPECIFICATIONS

Functions: Direction Indicator Category 6
Operating Voltage: 9-33V DC
Consumption: 3W
Type of protection: IP67

NEW

LED SIDE DIRECTION INDICATOR LAMP & MARKER LAMP

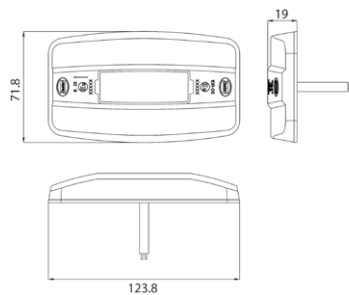

ECE APPROVED EMC APPROVED

REF. No
DSL-236.05 Amber lens, Chrome cap
DSL-236.07 Clear Lens, Chrome cap
DSL-236.RR Amber Lens, Reflector, Chrome cap
DSL-236B.05 Amber lens, black cap
DSL-236B.07 Clear Lens, black cap
DSL-236B.RR Amber Lens, Reflector, black cap

TECHNICAL SPECIFICATIONS

Functions: D.I, Category 6, Reflex Reflector (Optional)
Operating Voltage: 10-30V DC
Consumption: 1W
Type of protection: IP67

NEW

LED SIDE DIRECTION INDICATOR LAMP

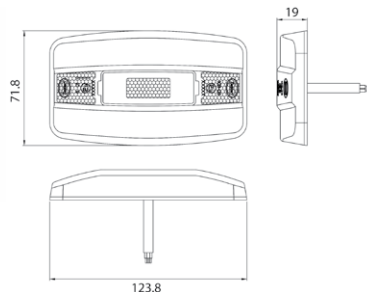

ECE APPROVED EMC APPROVED

REF. No
DSL-237.05 Amber lens, Chrome cap
DSL-237.RR Amber lens, Reflector, Chrome cap
DSL-237.05B Amber lens, Black cap
DSL-237.RRB Amber Lens, Reflector, Black cap

TECHNICAL SPECIFICATIONS

Functions: D.I, Category 6, Reflex Reflector (Optional)
Operating Voltage: 10-30V DC
Consumption: 1W
Type of protection: IP67

DIRECTION INDICATOR LAMPS

NEW

LED DIRECTION INDICATOR LAMP / DSL-260DIRF

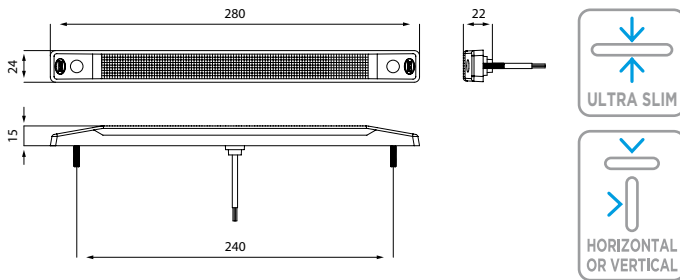

ECE APPROVED

EMC APPROVED

REF. No

DSL-260DIRF.05 Amber Lens

DSL-260DIRF.07 Clear Lens

TECHNICAL SPECIFICATIONS

Functions: Front or Rear D.I

Operating Voltage: 10-30V DC

Consumption: 4.5W

Type of Protection: IP67

Cable/Connector: 500 mm cable

REAR DIRECTION INDICATOR LAMP

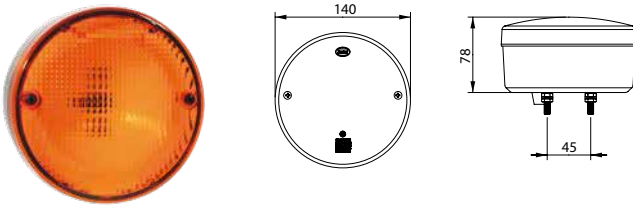

ECE APPROVED

REF. No

3100.05 With amber lens

P-3100.05 Spare lens, amber

TECHNICAL SPECIFICATIONS

Functions: Direction Indicator

Operating Voltage: 12 or 24V DC

Consumption: 1x21W

REAR DIRECTION INDICATOR LAMP

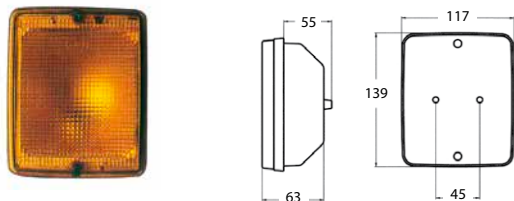

ECE APPROVED

REF. No

3000.05 With amber lens

P-3000.05 Spare lens, amber

TECHNICAL SPECIFICATIONS

Functions: Direction Indicator

Operating Voltage: 12 or 24V DC

Consumption: 1x21W

FRONT DIRECTION INDICATOR LAMP

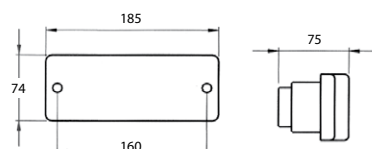

REF. No

8060/40R Right

8060/40L Left

P-8060-40R Spare lens, right

P-8060-40L Spare lens, left

TECHNICAL SPECIFICATIONS

Functions: Direction Indicator

Operating Voltage: 12 or 24V DC

Consumption: 1x21W

DIRECTION INDICATOR LAMPS

FRONT DIRECTION INDICATOR LAMP

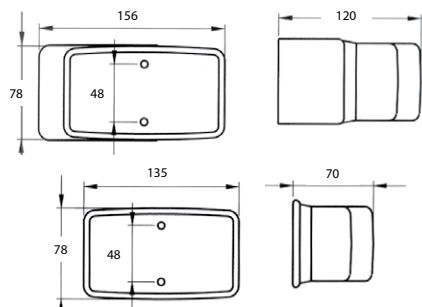

REF. No

8060/44R

Right with curved rubber base

8060/44L

Left with curved rubber base

8060/44RF

Right with flat rubber base

8060/44LF

Left with flat rubber base

P-8060-44R

Spare lens, right

P-8060-44L

Spare lens, left

TECHNICAL SPECIFICATIONS

Functions: Direction Indicator
Operating Voltage: 12 or 24V DC
Consumption: 1x21W

DIRECTION INDICATOR LAMP

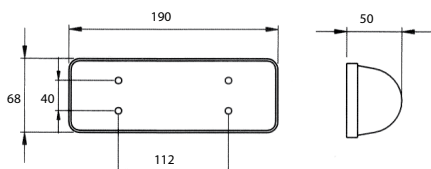

REF. No

8060/48.05

With amber lens

8060/48.07

With clear lens

P-8060-48.05

Spare lens, amber

P-8060-48.07

Spare lens, clear

TECHNICAL SPECIFICATIONS

Functions: Direction Indicator
Operating Voltage: 12 or 24V DC
Consumption: 2x21W

DIRECTION INDICATOR LAMP

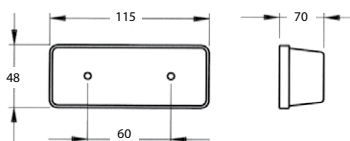

REF. No

8060/43.05

With amber lens

P-8060-43.05

Spare lens, amber

TECHNICAL SPECIFICATIONS

Functions: Direction Indicator
Operating Voltage: 12 or 24V
Consumption: 1x18W

FRONT / REAR DIRECTION INDICATOR LAMP / 1070 SERIES

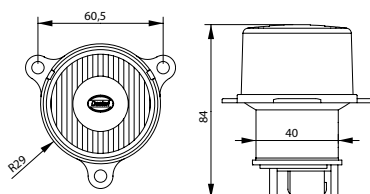

REF. No

1070-M004

Front with clear lens

1070-M004.05

Front with amber lens

TECHNICAL SPECIFICATIONS

Functions: Direction Indicator
Operating Voltage: 12 or 24V DC
Consumption: 1x21W

FRONT / SIDE DIRECTION INDICATOR LAMP



REF. No
8080/35
P-8080-35

Front or Side with amber lens
 Spare lens, amber

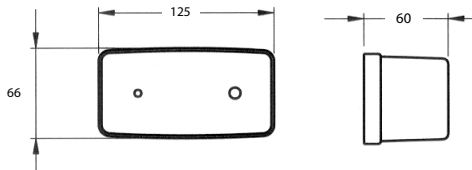

TECHNICAL SPECIFICATIONS

Functions: Direction Indicator
Operating Voltage: 12 or 24V DC
Consumption: 1x21W

SIDE DIRECTION INDICATOR LAMP



REF. No
8080/32
P-8080-32

Side with amber lens
 Spare lens, amber

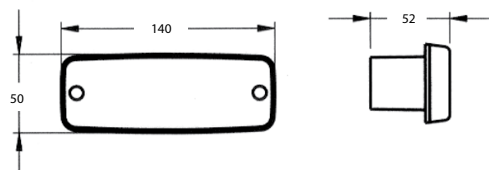

TECHNICAL SPECIFICATIONS

Functions: Direction Indicator
Operating Voltage: 12 or 24V DC
Consumption: 1x21W

FRONT / SIDE DIRECTION INDICATOR LAMP

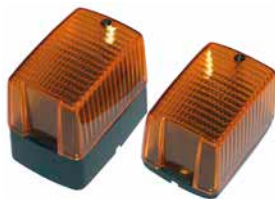

REF. No
8060/47
8060/47B
P-8060-47

Front or Side with amber lens
 Front or Side with long base & amber lens
 Spare lens, amber

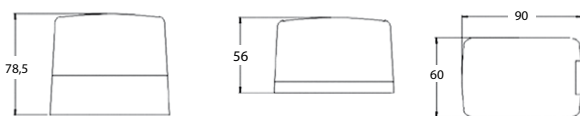

TECHNICAL SPECIFICATIONS

Functions: Direction Indicator
Operating Voltage: 12 or 24V DC
Consumption: 1x21W

ECE APPROVED

DIRECTION INDICATOR LAMP

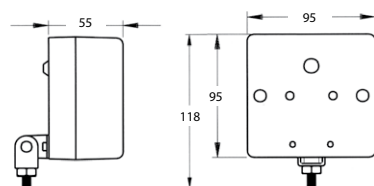

REF. No
8080/95B.05
P-8080-95.05

Amber with bracket
 Spare lens, amber

TECHNICAL SPECIFICATIONS

Functions: Direction Indicator
Operating Voltage: 12 or 24V DC
Consumption: 1x21W

ECE APPROVED

REAR DIRECTION INDICATOR LAMP

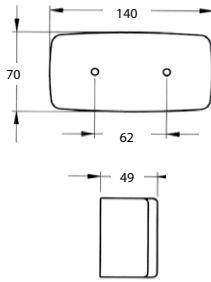

ECE APPROVED

REF. No

8080/96B.05

P-8080/96.05

Spare lens, amber

TECHNICAL SPECIFICATIONS

Functions: Direction Indicator

Operating Voltage: 12 or 24V DC

Consumption: 1x21W

DIRECTION INDICATOR LAMP

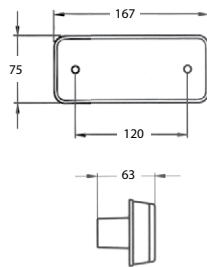

REF. No

8080/33

P-8080-33

With amber lens

Spare lens, amber

TECHNICAL SPECIFICATIONS

Functions: Direction Indicator

Operating Voltage: 12 or 24V DC

Consumption: 1x21W

DIRECTION INDICATOR LAMP

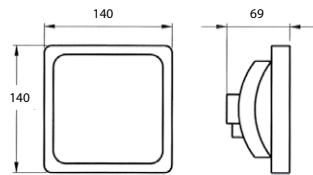
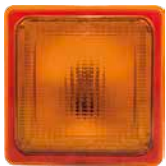

REF. No

8060/46.05

P-8060-46.05

With amber lens

Spare lens, amber

TECHNICAL SPECIFICATIONS

Functions: Direction Indicator

Operating Voltage: 12 or 24V DC

Consumption: 1x21W

DIRECTION INDICATOR LAMP

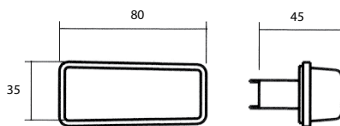

REF. No

8080/37.05

8080/37.07

With amber lens

With clear lens

TECHNICAL SPECIFICATIONS

Functions: Direction Indicator

Operating Voltage: 12 or 24V DC

Consumption: 1x3W

FRONT DIRECTION INDICATOR LAMP

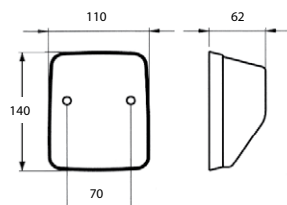

ECE APPROVED

REF. No

8080/36

8080/36.07

P-8080-36

P-8080-36.07

With amber lens

With clear lens

Spare lens, amber

Spare lens, clear

TECHNICAL SPECIFICATIONS

Functions: Direction Indicator

Operating Voltage: 12 or 24V DC

Consumption: 1x21W



REVERSING LAMPS





REVERSING LAMPS

NEW

LED REVERSING LAMP

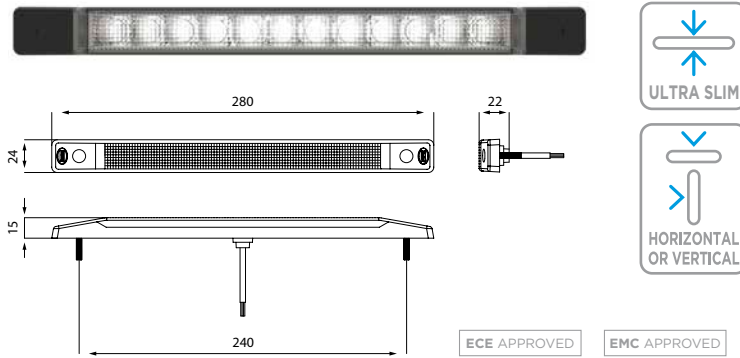

REF. No
DSL-260RL Clear lens

TECHNICAL SPECIFICATIONS

Functions: Reverse
Operating Voltage: 10-30V DC
Consumption: 4W
Type of Protection: IP67
Cable/Connector: 500 mm cable

LED REVERSING LAMP

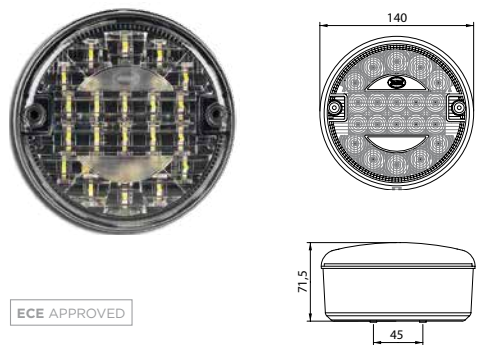

REF. No
DSL-31042W LED Reversing lamp

TECHNICAL SPECIFICATIONS

Operating Voltage: 9-33V DC
Functions: Reversing
Consumption: (12/24V) 2,3/2,4W
Type of Protection: IP67

LED REVERSING LAMP

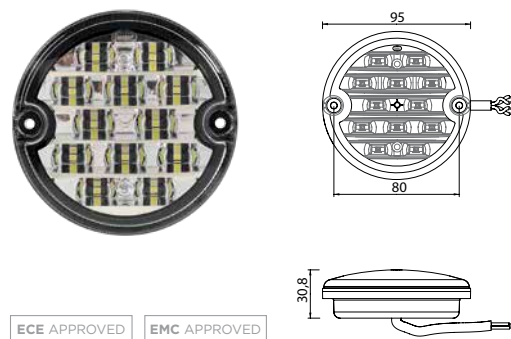

REF. No
DSL-210RL LED Reversing lamp

TECHNICAL SPECIFICATIONS

Operating Voltage: 9-33V DC
Functions: Reversing
Consumption: 3W
Type of Protection: IP67

LED REVERSING LAMP

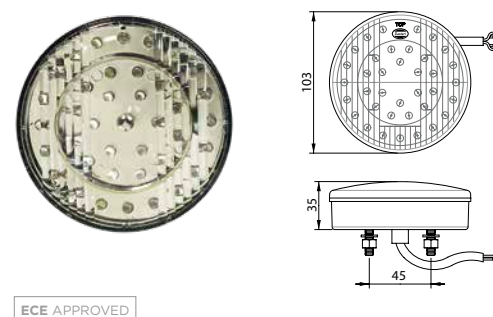

REF. No
DSL-24/12 12V LED Reversing lamp
DSL-24/24 24V LED Reversing lamp

TECHNICAL SPECIFICATIONS

Operating Voltage: 12 or 24V DC
Functions: Reversing
Consumption: (12V/24V) 2.7W/2W
Type of Protection: IP67

LED WORK/REVERSING LAMP

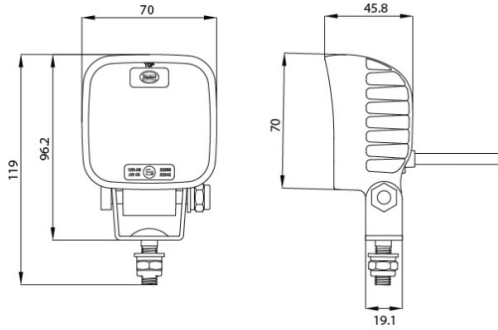

ECE APPROVED

EMC APPROVED

REF. No

WRL-LED-50

LED Work/
Reversing Lamp

TECHNICAL SPECIFICATIONS

Operating Voltage: 10V-30V DC

Consumption: 12W

Type of Protection: IP67

Cable/Connector: 1000 mm cable

Install it under certain angle to have a Reverse ECE certified solution

LED REVERSING LAMP

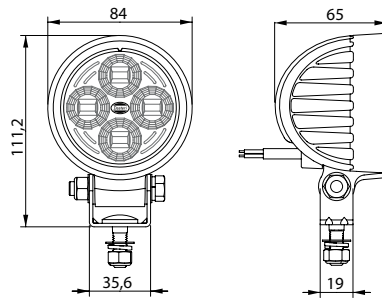

ECE APPROVED

REF. No

RVL-LED-80

LED Reversing lamp

TECHNICAL SPECIFICATIONS

Operating Voltage: 10-30V DC

Functions: Reversing

Consumption: 2W

Type of Protection: IP67

LED REVERSING LAMP

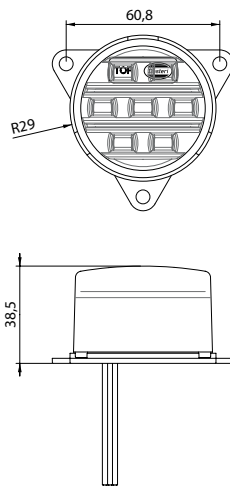

ECE APPROVED

EMC APPROVED

REF. No

DSL0400RVL

LED Reversing lamp

TECHNICAL SPECIFICATIONS

Operating Voltage: 9-33V DC

Functions: Reversing

Consumption: 2W

Type of Protection: IP67

REVERSING LAMP

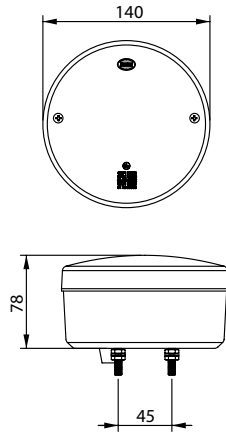
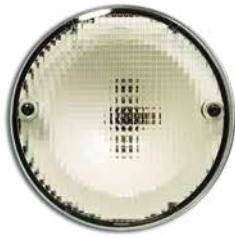

ECE APPROVED

REF. No

3104.07

P-3100.07

Reversing lamp

Spare lens

TECHNICAL SPECIFICATIONS

Operating Voltage: 12 or 24V DC

Functions: Reversing

Consumption: 1x21W

REVERSING LAMP

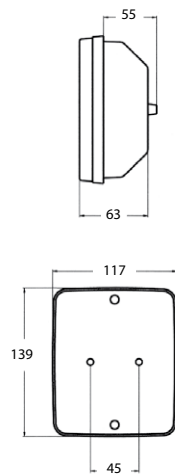

ECE APPROVED

REF. No

3004.07

P-3000.07

Reversing lamp

Spare lens

TECHNICAL SPECIFICATIONS

Operating Voltage: 12 or 24V DC

Functions: Reversing

Consumption: 1x21W

REVERSING LAMP

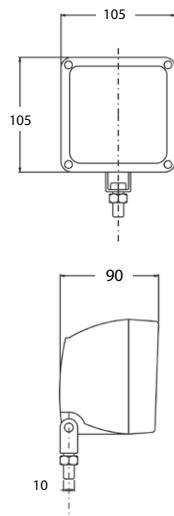

ECE APPROVED

REF. No

W160-GRL

W163-GRL

Reversing lamp

Reversing lamp with connector and base

TECHNICAL SPECIFICATIONS

Operating Voltage: 12 or 24V DC

Functions: Reversing

Consumption: 12V 55W (H3)

24V 70W (H3)

REVERSING LAMPS

REVERSING LAMP

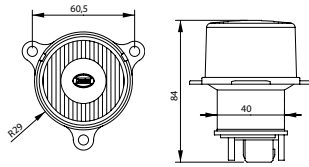

REF. No
1070-M042

Reversing lamp

TECHNICAL SPECIFICATIONS

Operating Voltage: 12 or 24V DC
Functions: Reversing
Consumption: 1x21W

ECE APPROVED

REVERSING LAMP

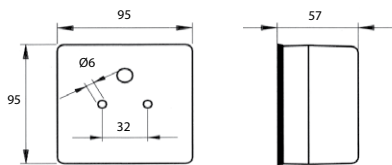

REF. No
8080/95.07
P-8080-95.07

Reversing lamp
Spare lens

TECHNICAL SPECIFICATIONS

Operating Voltage: 12 or 24V DC
Functions: Reversing
Consumption: 1x21W

ECE APPROVED

REVERSING LAMP

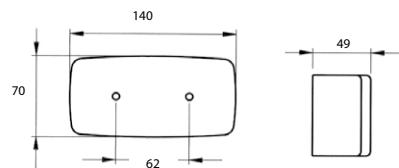

REF. No
8080/96.07
P-8080-96.07

Reversing lamp
Spare lens

TECHNICAL SPECIFICATIONS

Operating Voltage: 12 or 24V DC
Functions: Reversing
Consumption: 1x21W

REVERSING LAMP

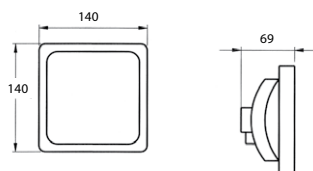

REF. No
8060/46.07
P-8060-46.07

Reversing lamp
Spare lens

TECHNICAL SPECIFICATIONS

Operating Voltage: 12 or 24V DC
Functions: Reversing
Consumption: 1x21W



FOG LAMPS

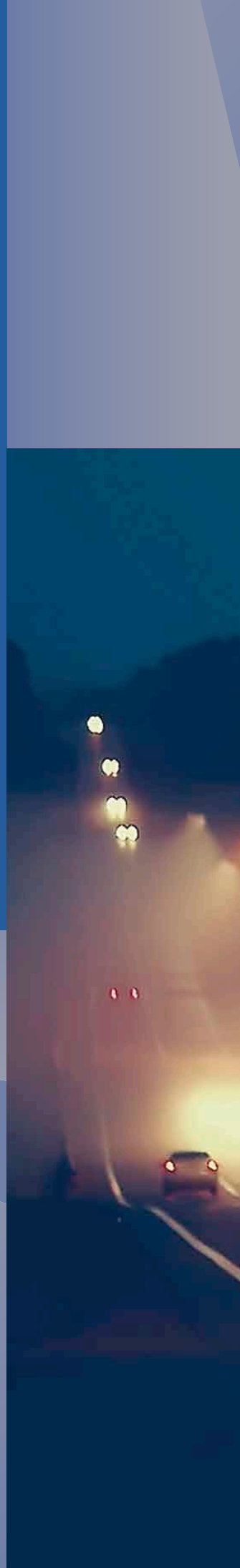



NEW

LED FOG LAMP

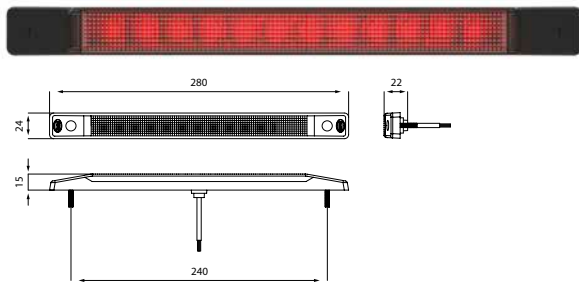

REF. No
DSL-260FL.06 Red Lens
DSL-260FL.07 Clear Lens

TECHNICAL SPECIFICATIONS
Functions: Fog
Operating Voltage: 10-30V DC
Consumption: 5W
Type of Protection: IP67
Cable/Connector: 500 mm cable

ECE APPROVED EMC APPROVED

LED FOG LAMP

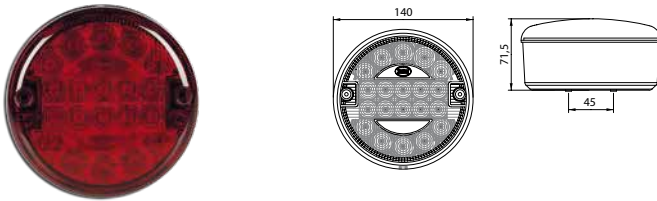

REF. No
DSL-31032R With red lens

TECHNICAL SPECIFICATIONS
Operating Voltage: 9-33V DC
Functions: Fog
Consumption: (12/24V) 2,7W/2,8W
Type of Protection: IP67

ECE APPROVED

LED FOG LAMP

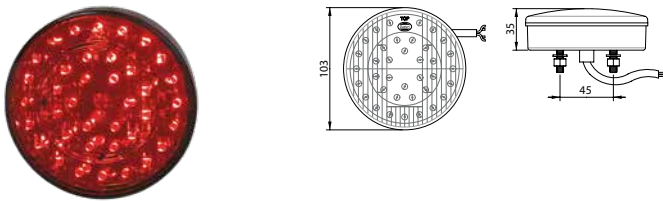

REF. No
DSL-23/12 With red lens 12V
DSL-23/24 With red lens 24V

TECHNICAL SPECIFICATIONS
Operating Voltage: 12 or 24V DC
Functions: Fog
Consumption: 2W
Type of Protection: IP67

ECE APPROVED

LED FOG LAMP



REF. No
DSL-210FL With red lens

TECHNICAL SPECIFICATIONS
Operating Voltage: 9-33V DC
Functions: Fog
Consumption: 4W
Type of Protection: IP67

ECE APPROVED EMC APPROVED

LED FOG LAMP

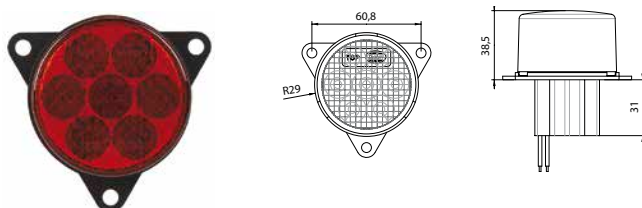

REF. No
DSL0400FLR With red lens

TECHNICAL SPECIFICATIONS
Operating Voltage: 9-33V DC
Functions: Fog
Consumption: 4W
Type of Protection: IP67

ECE APPROVED EMC APPROVED SAE DOT APPROVED

FOG LAMPS

FOG LAMP

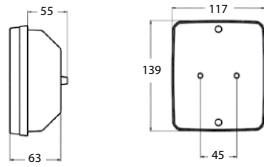

ECE APPROVED

REF. No

3003.06

With red lens

P-3000.06

Spare lens, red

TECHNICAL SPECIFICATIONS

Operating Voltage: 12 or 24V DC

Functions: Fog

Consumption: 1x21W

FOG LAMP

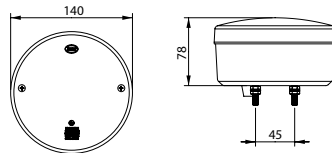

ECE APPROVED

REF. No

3103.06

With red lens

P-3100.06

Spare lens, red

TECHNICAL SPECIFICATIONS

Operating Voltage: 12 or 24V DC

Functions: Fog

Consumption: 1x21W

FOG LAMP

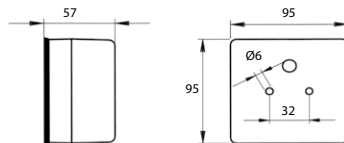

ECE APPROVED

REF. No

8080/95.06

With red lens and rubber base

P-8080-95.06

Spare lens, red

TECHNICAL SPECIFICATIONS

Operating Voltage: 12 or 24V DC

Functions: Fog

Consumption: 1x21W

FOG LAMP

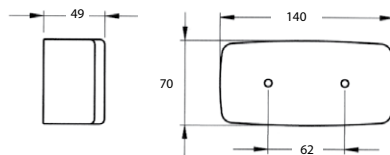

ECE APPROVED

REF. No

8080/96.06

With red lens and rubber base

P-8080-96.06

Spare lens, red

TECHNICAL SPECIFICATIONS

Operating Voltage: 12 or 24V DC

Functions: Fog

Consumption: 1x21W

FOG LAMP

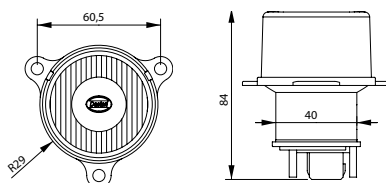

ECE APPROVED

REF. No

1070-M162

With red lens

TECHNICAL SPECIFICATIONS

Operating Voltage: 12 or 24V DC

Functions: Fog

Consumption: 1x21W



STOP LAMPS & CHMSL





NEW

LED CHMSL (THIRD STOP LAMP)

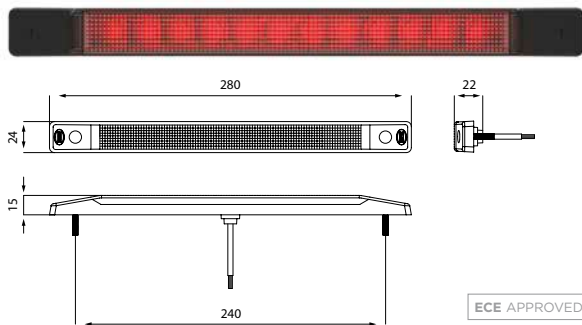

REF. No
DSL-260S3.06 Red Lens
DSL-260S3.07 Clear Lens

TECHNICAL SPECIFICATIONS

Functions: 3rd Stop
Operating Voltage: 10-30V DC
Consumption: 2.5W
Type of Protection: IP67
Cable/Connector: 500 mm cable

ECE APPROVED EMC APPROVED

LED CHMSL (THIRD STOP LAMP)

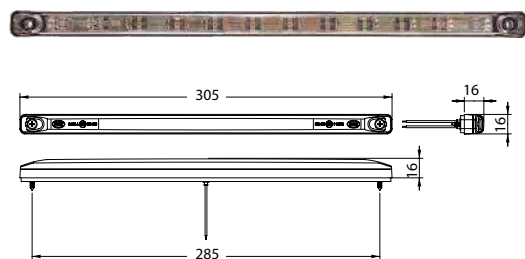

REF. No
DSL-12S312 Third stop lamp 12V, clear lens
DSL-12S324 Third stop lamp 24V, clear lens
DSL-12S312.06 Third stop lamp 12V, red lens
DSL-12S324.06 Third stop lamp 24V, red lens

TECHNICAL SPECIFICATIONS

Operating Voltage: 12 or 24V DC
Functions: Third Stop
Consumption: 1W
Type of Protection: IP67

ECE APPROVED EMC APPROVED SAE DOT APPROVED

LED CHMSL (THIRD STOP LAMP)

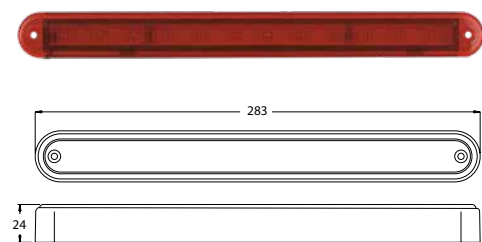

REF. No
DSL-12.1206 Third stop lamp 12V
DSL-24.1206 Third stop lamp 24V

TECHNICAL SPECIFICATIONS

Operating Voltage: 12 or 24V DC
Functions: Third Stop
Consumption: 5W
Type of Protection: IP67

ECE APPROVED EMC APPROVED

LED CHMSL (THIRD STOP LAMP)

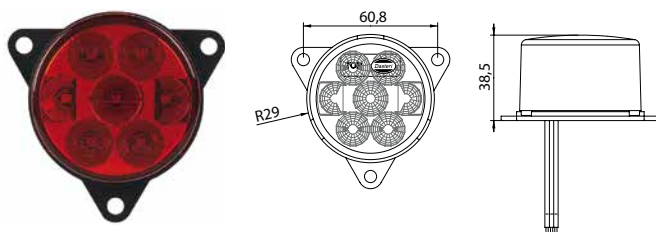

REF. No
DSL0400S3.1 Third stop lamp

TECHNICAL SPECIFICATIONS

Operating Voltage: 10-30V DC
Functions: Third Stop
Consumption: 2W
Type of Protection: IP67

ECE APPROVED

STOP LAMP

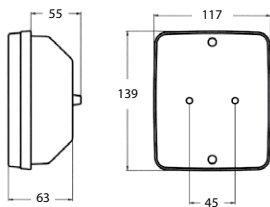

REF. No
3002.06 Stop lamp
P-3000.06 Spare lens, red

TECHNICAL SPECIFICATIONS
Operating Voltage: 12 or 24V DC
Functions: Stop
Consumption: 1x21W

ECE APPROVED

STOP LAMP

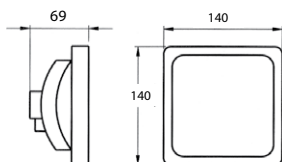

REF. No
8060/46.06 Stop lamp
P-8060-46.06 Spare lens, red

TECHNICAL SPECIFICATIONS
Operating Voltage: 12 or 24V DC
Functions: Stop
Consumption: 1x21W

STOP LAMP

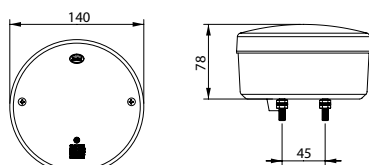

REF. No
3102.06 Stop lamp
P-3100.06 Spare lens, red

TECHNICAL SPECIFICATIONS
Operating Voltage: 12 or 24V DC
Functions: Stop
Consumption: 1x21W

ECE APPROVED

STOP LAMP

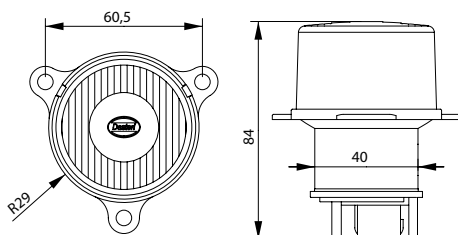

REF. No
1070-M142 Stop lamp

TECHNICAL SPECIFICATIONS
Operating Voltage: 12 or 24V DC
Functions: Stop
Consumption: 1x21W

ECE APPROVED



WORK LAMPS





LED WORK LAMP WRK-LED-40 SERIES

TECHNICAL SPECIFICATIONS

Operating Voltage: 10 - 30V DC
Lumens Output: 840 lm
Consumption: 10W
Operating Temperature: -40 °C to + 85 °C
Type of Protection: IP67

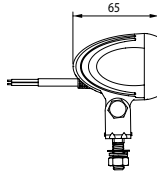
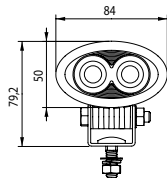

EMC APPROVED

SPOT

REF. No **WRK-LED-40S**

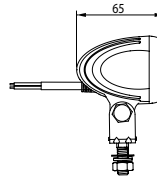
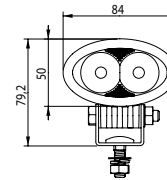

EMC APPROVED

NARROW SPOT

REF. No **WRK-LED-40NS**

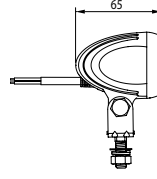
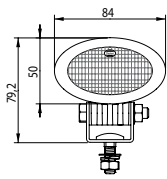

EMC APPROVED

FLOOD

REF. No **WRK-LED-40F**

LED WORK / REVERSING LAMP

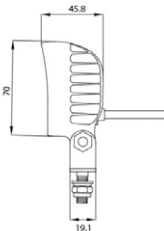
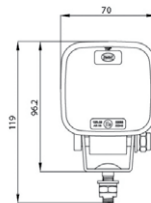

ECE APPROVED

EMC APPROVED

REF. No **WRL-LED-50**

TECHNICAL SPECIFICATIONS

Operating Voltage: 10V-30V DC
Consumption: 12W
Type of Protection: IP67
Cable/Connector: 1000 mm cable

Install it under certain angle to have a Reverse ECE certified solution

LED WORK LAMP

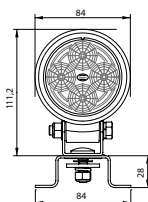
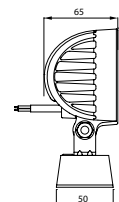

EMC APPROVED

REF. No

WRK-LED-80

LED work lamp

WRK-LED-80BL

LED work lamp, Blue emitting light (for agricultural use)

TECHNICAL SPECIFICATIONS

Operating Voltage: 10-30V DC
Consumption: 9W
Operating Temperature: -40 °C to +80 °C
Light Output: 600 lm
Type of Protection: IP67

WORK LAMPS

NEW LED WORK / REVERSING LAMP

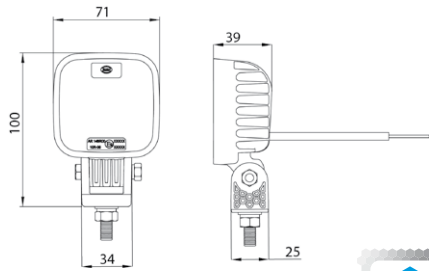

ECE APPROVED

EMC APPROVED



REF. No

WRL-LED-55

Cable Output

WRL-LED-55DT

Deutsch Connector

TECHNICAL SPECIFICATIONS

Operating Voltage: 10-30V DC

Consumption: 12W

Type of Base: Regular

Type of Protection: IP69K

Cable/Connector: 300 mm cable / Integrated 2-pin Deutsch Connector

Output: 1800 lm

NEW LED WORK / RESERVING LAMP

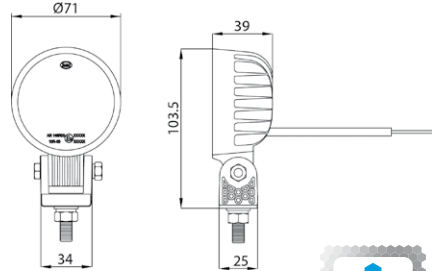

ECE APPROVED

EMC APPROVED



REF. No

WRL-LED-60

Cable Output

WRL-LED-60DT

Deutsch Connector

TECHNICAL SPECIFICATIONS

Operating Voltage: 10-30V DC

Consumption: 12W

Type of Base: Regular

Type of Protection: IP69K

Cable/Connector: 300 mm cable / Integrated 2-pin Deutsch Connector

Output: 1560 lm

NEW LED WORK LAMP

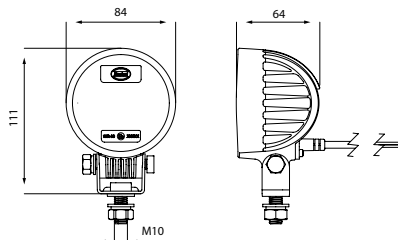

ECE APPROVED

EMC APPROVED



REF. No

WRK-LED-85

Cable Output

WRK-LED-85DT

Deutsch Connector

TECHNICAL SPECIFICATIONS

Operating Voltage: 10-30V DC

Consumption: 20W

Type of Base: Regular

Type of Protection: IP69K

Cable/Connector: 300 mm cable / Integrated 2-pin Deutsch Connector

Output: 2000 lm

NEW LED WORK LAMP

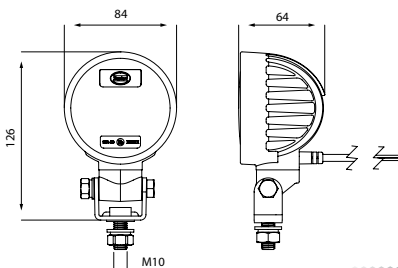

ECE APPROVED

EMC APPROVED



REF. No

WRK-LED-85R

Cable Output

WRK-LED-85RDT

Deutsch Connector

TECHNICAL SPECIFICATIONS

Operating Voltage: 10-30V DC

Consumption: 20W

Type of Housing: Rotatable

Type of Protection: IP69K

Cable/Connector: 300 mm cable / Integrated 2-pin Deutsch Connector

Output: 2000 lm

WORK LAMPS

NEW LED WORK LAMP

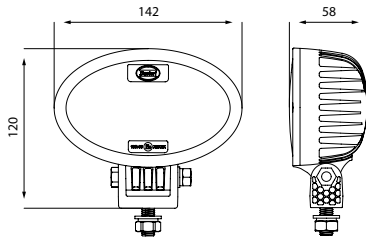

EMC APPROVED

REF. No
WRL-LED-125 Cable Output
WRL-LED-125DT Deutsch Connector

TECHNICAL SPECIFICATIONS

Operating Voltage: 10-30V DC
Consumption: 40W
Type of Base: Regular
Type of Protection: IP69
Cable/Connector: 300 mm cable / Integrated 2-pin Deutsch Connector
Output: 5200 lm

NEW LED WORK LAMP

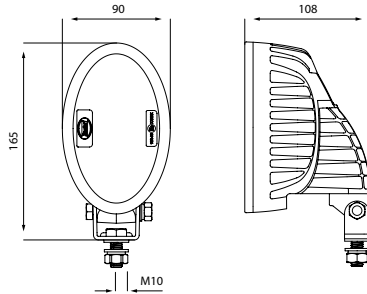

EMC APPROVED

REF. No
WRL-LED-125R Cable Output
WRL-LED-125RDT Deutsch Connector

TECHNICAL SPECIFICATIONS

Operating Voltage: 10-30V DC
Consumption: 40W
Type of Base: Rotatable
Type of Protection: IP69
Cable/Connector: 300 mm cable / Integrated 2-pin Deutsch Connector
Output: 4000 lm

NEW LED WORK LAMP

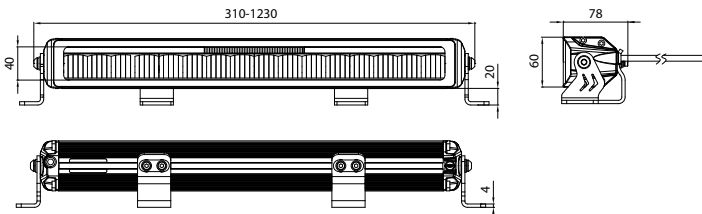

ECE APPROVED

EMC APPROVED

REF. No **WWP-100**

TECHNICAL SPECIFICATIONS

Functions: Front Position, Warning Lamp, Ambient Light, Work Lamp
Operating Voltage: 10-30V
Consumption: F.P.: 1,3W WA: 6,7W Ambient: 6,7W Work: 80-200W
Type of Protection: IP69K
Cable/Connector: 500 mm cable / Integrated 2-pin Deutsch Connector
Output: 5000lm - 19200lm

REF. No	Length (mm)	Lumen Output (Work Lamp)
WWP-100	310	5000
WWP-101	540	7700
WWP-102	770	11500
WWP-103	1000	15400
WWP-104	1230	19200

WORK LAMPS

LED WORK LAMP

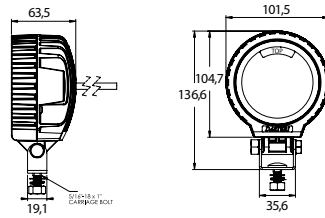

REF. No

WRK-LED-100

LED work lamp

WRK-LED-100S

LED work lamp, spot

TECHNICAL SPECIFICATIONS

Operating Voltage: 10-30V DC
Consumption: 12W
Operating Temperature: -40 °C to +60 °C
Light Output: 500 lm
Type of Protection: IP67

LED WORK LAMP

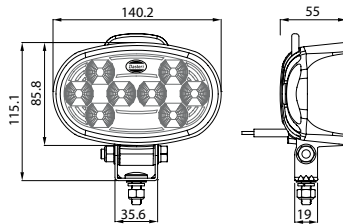

REF. No

WRK-LED-120

LED work lamp

TECHNICAL SPECIFICATIONS

Operating Voltage: 10-30V DC
Consumption: 16,5W
Operating Temperature: -40 °C to +80 °C
Light Output: 1200 lm
Type of Protection: IP67

EMC APPROVED

LED WORK LAMP

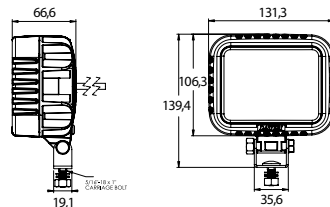

REF. No

WRK-LED-150

LED work lamp

WRK-LED-150S

LED work lamp, spot

TECHNICAL SPECIFICATIONS

Operating Voltage: 10-50V DC
Consumption: (12V/24V) 30W/27W
Operating Temperature: -40 °C to +60 °C
Light Output: 1400 lm
Type of Protection: IP67

LED WORK LAMP

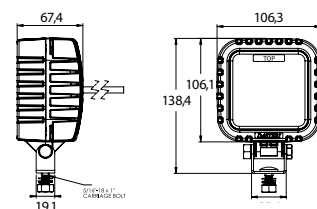

REF. No

WRK-LED-160

LED work lamp

WRK-LED-160S

LED work lamp, spot

TECHNICAL SPECIFICATIONS

Operating Voltage: 10-50V DC
Consumption: (12V/24V) 22W/20W
Operating Temperature: -40 °C to +60 °C
Light Output: 1000 lm
Type of Protection: IP67

LED WORK LAMP

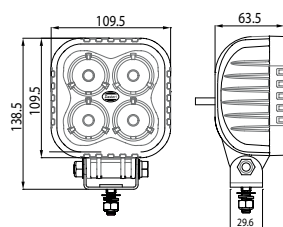

REF. No

WRK-LED-180

1800 Lumens

WRK-LED-180H

3600 Lumens

TECHNICAL SPECIFICATIONS

Operating Voltage: 9-32V DC
Light Output: 1800 / 3600 lm
Consumption: 1800 lm 22W, 3600 lm 36W
Operating Temperature: -40 °C + 85 °C
Type of Protection: IP69

EMC APPROVED

WORK LAMPS

LED WORK LAMP

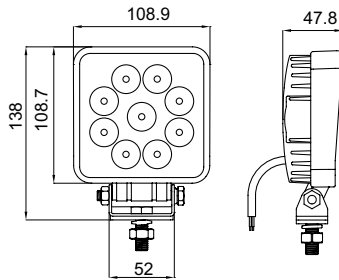

REF. No
WRKE-LED-200F Flood Beam
WRKE-LED-200S Spot Beam

TECHNICAL SPECIFICATIONS

Operating Voltage: 10-30V DC
Consumption: 27W
Operating Temperature: -40 °C to +80 °C
Lumen Output: 2000 lm
Type of Protection: IP67

NEW

LED WORK LAMP

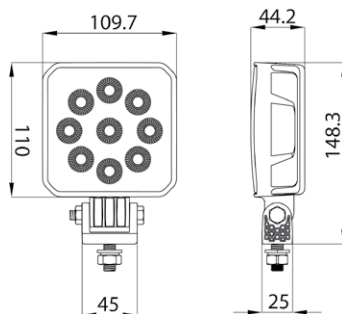

REF. No **WRK-LED-205**

TECHNICAL SPECIFICATIONS

Operating Voltage: 10-30V DC
Consumption: 27/36W
Type of base: Regular
Type of Protection: IP69K
Cable/Connector: 300 mm cable / Integrated 2-pin Deutsch Connector
Output: 2250lm / 4550lm

EMC APPROVED



REF. No	Cable Output	Deutsch Connector	2250LM	4550LM
WRK-LED-205	•		•	
WRK-LED-205DT		•	•	
WRK-LED-205H	•			•
WRK-LED-205HDT		•		•

NEW

LED WORK LAMP

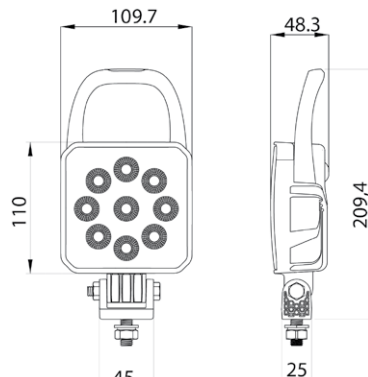

REF. No **WRK-LED-206**

TECHNICAL SPECIFICATIONS

Operating Voltage: 10-30V DC
Consumption: 27/45W
Type of base: Regular
Type of Protection: IP69K
Cable/Connector: 300 mm cable / Integrated 2-pin Deutsch Connector
Output: 2250lm / 4550lm

ECE APPROVED

EMC APPROVED



REF. No	Cable Output	Deutsch Connector	2250LM	4550LM
WRK-LED-206	•		•	
WRK-LED-206DT		•	•	
WRK-LED-206H	•			•
WRK-LED-206HDT		•		•

WORK LAMPS

NEW LED WORK LAMP

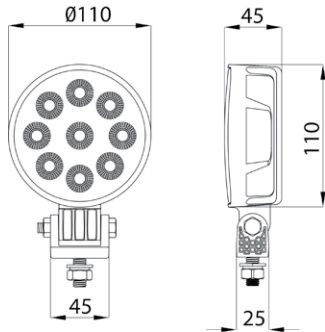

EMC APPROVED

REF. No **WRK-LED-215**

TECHNICAL SPECIFICATIONS

Operating Voltage: 10-30V DC
Consumption: 27/45W
Type of base: Regular
Type of Protection: IP69K
Cable/Connector: 300 mm cable / Integrated 2-pin Deutsch Connector
Output: 2250lm / 4550lm

REF. No	Cable Output	Deutsch Connector	2250LM	4550LM
WRK-LED-215	•		•	
WRK-LED-215DT		•	•	
WRK-LED-215H	•			•
WRK-LED-215HDT		•		•

NEW LED WORK LAMP

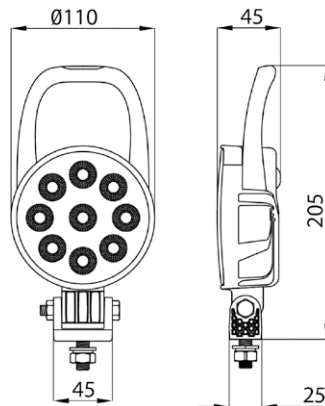

EMC APPROVED

REF. No **WRK-LED-216**

TECHNICAL SPECIFICATIONS

Operating Voltage: 10-30V DC
Consumption: 27/45W
Type of base: Regular
Type of Protection: IP69K
Cable/Connector: 300 mm cable / Integrated 2-pin Deutsch Connector
Output: 2250lm / 4550lm

REF. No	Cable Output	Deutsch Connector	2250LM	4550LM
WRK-LED-216	•		•	
WRK-LED-216DT		•	•	
WRK-LED-216H	•			•
WRK-LED-216HDT		•		•

LED WORK LAMP

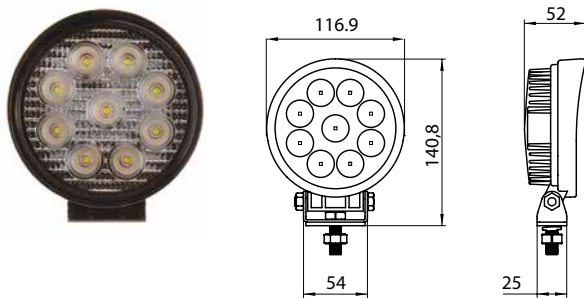

REF. No
WRKE-LED-210F Flood Beam
WRKE-LED-210S Spot Beam

TECHNICAL SPECIFICATIONS
Operating Voltage: 10-30V DC
Consumption: 27W
Operating Temperature: -40 °C to +80 °C
Light Output: 2000 lm
Type of Protection: IP67

LED WORK LAMP

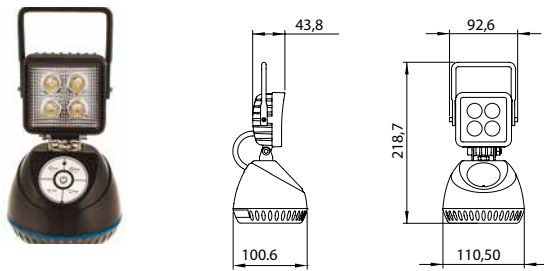

REF. No
WRKR-LED-10 Rechargeable handheld LED work lamp, with on/off and color change switch (yellow/white)

TECHNICAL SPECIFICATIONS
Operating Voltage: 10-30V DC
Consumption: 12W
Operating Temperature: -40 °C to +60 °C
Lumen Output: 840 lm
Type of Protection: IP67

WORK LAMP

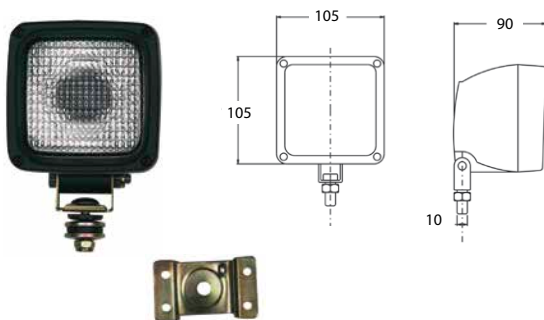

REF. No
W160-G Work lamp
W161-G With U-shaped metal base
W162-G With connector
W163-G With U-shaped metal base and connector

TECHNICAL SPECIFICATIONS
Operating Voltage: 12 or 24V DC
Consumption: 12V 55W (H3) / 24V 70W (H3)
Type of Protection: IP67

* G: Glass Lens

WORK LAMP

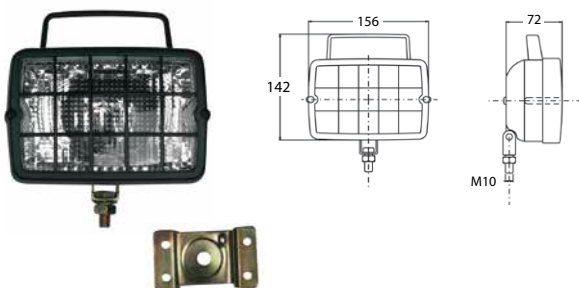

REF. No
W152-G With handled
W152-G/g With handled and grill
W153-G With handled and U-shaped metal base
W153-G/g With handled, grill and U-shaped metal base

TECHNICAL SPECIFICATIONS
Operating Voltage: 12 or 24V DC
Consumption: 12V 55W (H3) / 24V 70W (H3)

* G: Glass Lens / g: Grill

WORK LAMPS

WORK LAMP

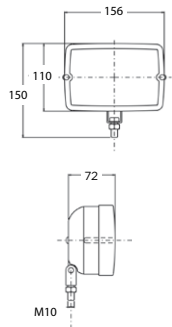

REF. No

- W150-G** Work lamp
- W150-G/g** With grill
- W151-G** With U-shaped metal base
- W151-G/g** With grill and U-shaped metal base
- W154-G** Work lamp
- W155-G** Work lamp with U-shaped metal base

TECHNICAL SPECIFICATIONS

- Operating Voltage:** 12 or 24V DC
- Consumption:** 12V 55W (H3) / 24V 70W (H3)

* G: Glass Lens / g: Grill

WORK LAMP

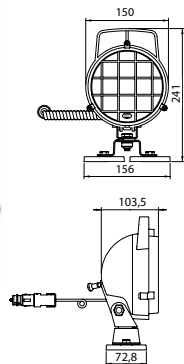

REF. No

- 130-GG/M** With magnetic base and cigarette plug

TECHNICAL SPECIFICATIONS

- Operating Voltage:** 12 or 24V DC
- Consumption:** 12V 55W (H3) / 24V 70W (H3)

WORK LAMP

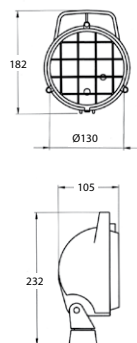

REF. No

- 130-P** With PC lens (H3 12V)
- 130-P/g** With PC lens and grill (H3 12V)
- 130-G** With glass lens switch (H3 12/24V)
- 130-G/g** With glass lens switch and grill (H3 12/24V)

TECHNICAL SPECIFICATIONS

- Operating Voltage:** 12 or 24V DC
- Consumption:** 12V 55W (H3) / 24V 70W (H3)

* G: Glass Lens / g: Grill

MAIN OR OPERATING HEADLAMP

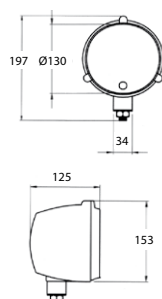

REF. No

- HL-1.001** Headlamp with side cable exit
- HL-1.002** Headlamp with bottom cable exit

TECHNICAL SPECIFICATIONS

- Operating Voltage:** 12 or 24V DC
- Consumption:** 12V: R2 (45/40 W) P45t H4
24V: R2 (55 / 50 W) P45t
- Fitting:** M14



NUMBER PLATE LAMPS

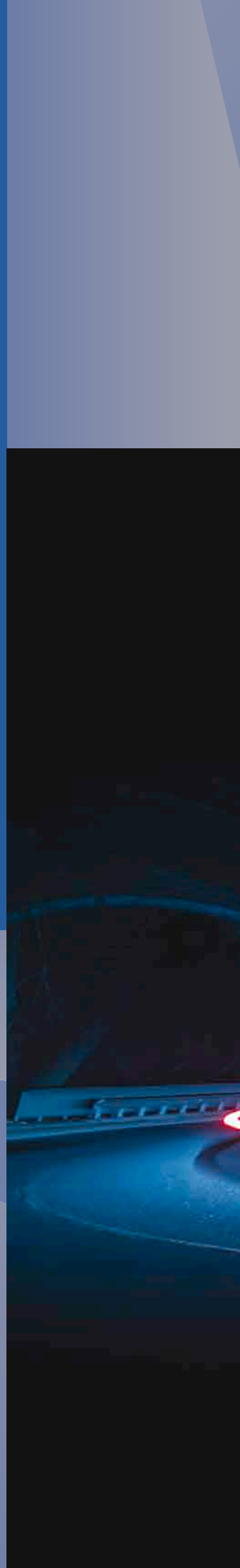



LED NUMBER PLATE LAMP

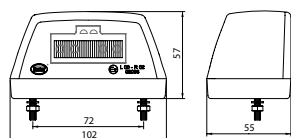

ECE APPROVED

REF. No

DSL-41A/12 12 Volt **L-41A/12** Lens with LED unit 12V
DSL-41A/24 24 Volt **L-41A/24** Lens with LED unit 24V

TECHNICAL SPECIFICATIONS

Functions: Number Plate Lamp
Operating Voltage: 12 or 24V DC
Consumption: 0,5W
Type of protection: IP67

LED TAIL - NUMBER PLATE LAMP

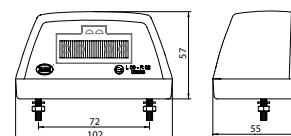

ECE APPROVED

REF. No

DSL-41B/12 12 Volt **L-41B/12** Lens with LED unit 12V
DSL-41B/24 24 Volt **L-41B/24** Lens with LED unit 24V

TECHNICAL SPECIFICATIONS

Functions: Number Plate Lamp
Operating Voltage: 12 or 24V DC
Consumption: 0,5W
Type of protection: IP67

LED NUMBER PLATE LAMP

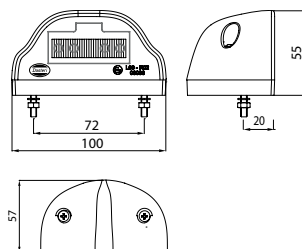

ECE APPROVED

REF. No

DSL-43A/12 12 Volt **L-43A/12** Lens with LED unit 12V
DSL-43A/24 24 Volt **L-43A/24** Lens with LED unit 24V

TECHNICAL SPECIFICATIONS

Functions: Number Plate Lamp
Operating Voltage: 12 or 24V DC
Consumption: 0,5W
Type of protection: IP67

LED TAIL - NUMBER PLATE LAMP

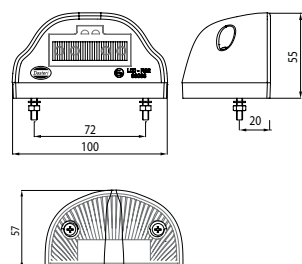

ECE APPROVED

REF. No

DSL-43B/12 12 Volt **L-43B/12** Lens with LED unit 12V
DSL-43B/24 24 Volt **L-43B/24** Lens with LED unit 24V

TECHNICAL SPECIFICATIONS

Functions: Number Plate Lamp
Operating Voltage: 12 or 24V DC
Consumption: 0,5W
Type of protection: IP67

LED NUMBER PLATE LAMP

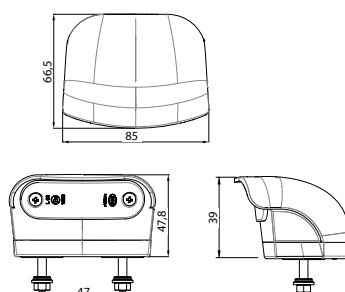

ECE APPROVED

REF. No

DSL-42A/12 12 Volt
DSL-42A/24 24 Volt

TECHNICAL SPECIFICATIONS

Functions: Number Plate Lamp
Operating Voltage: 12 or 24V DC
Consumption: 1,2W
Type of protection: IP67

NUMBER PLATE LAMPS

LED NUMBER PLATE LAMP



ECE APPROVED

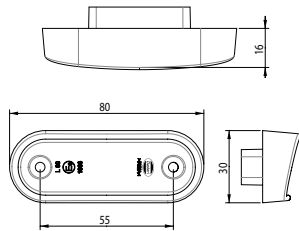

REF. No

DSL-44/12 12 Volt
DSL-44/24 24 Volt

TECHNICAL SPECIFICATIONS

Functions: Number Plate Lamp
Operating Voltage: 12 or 24V DC
Consumption: 1,2W
Type of protection: IP67

LED NUMBER PLATE LAMP



ECE APPROVED

EMC APPROVED

SAE DOT APPROVED

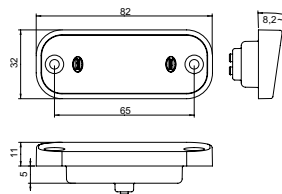

REF. No

DSL-45 LED Number Plate Lamp

TECHNICAL SPECIFICATIONS

Operating Voltage: 10-30V DC
Consumption: 1W
Type of Protection: IP67

LED NUMBER PLATE LAMP



ECE APPROVED

EMC APPROVED

SAE DOT APPROVED

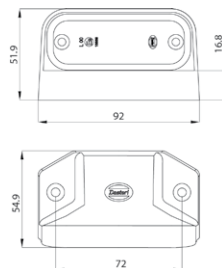

REF. No

DSL-45B

TECHNICAL SPECIFICATIONS

Operating Voltage: 10-30V DC
Consumption: 1W
Type of Protection: IP67

NUMBER PLATE LAMP



ECE APPROVED

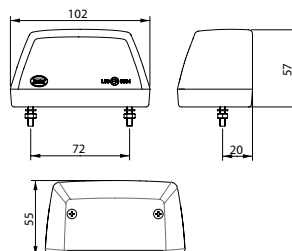

REF. No

8060/41A With black cover
8060/41B With red cover

TECHNICAL SPECIFICATIONS

Functions: Number Plate Lamp
Operating Voltage: 12 or 24V DC
Consumption: 1x5W

NUMBER PLATE LAMP



ECE APPROVED

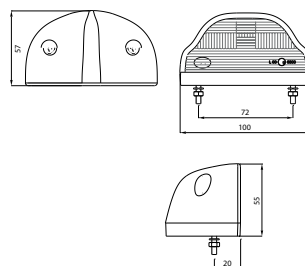

REF. No

8060/43A With black cover

TECHNICAL SPECIFICATIONS

Functions: Number Plate Lamp
Operating Voltage: 12 or 24V DC
Consumption: 1x5W

NUMBER PLATE LAMP

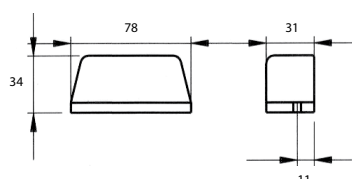

REF. No

8060/42 With black cover

TECHNICAL SPECIFICATIONS

Functions: Number Plate Lamp
Operating Voltage: 12 or 24V DC
Consumption: 1x5W



MARKER LAMPS

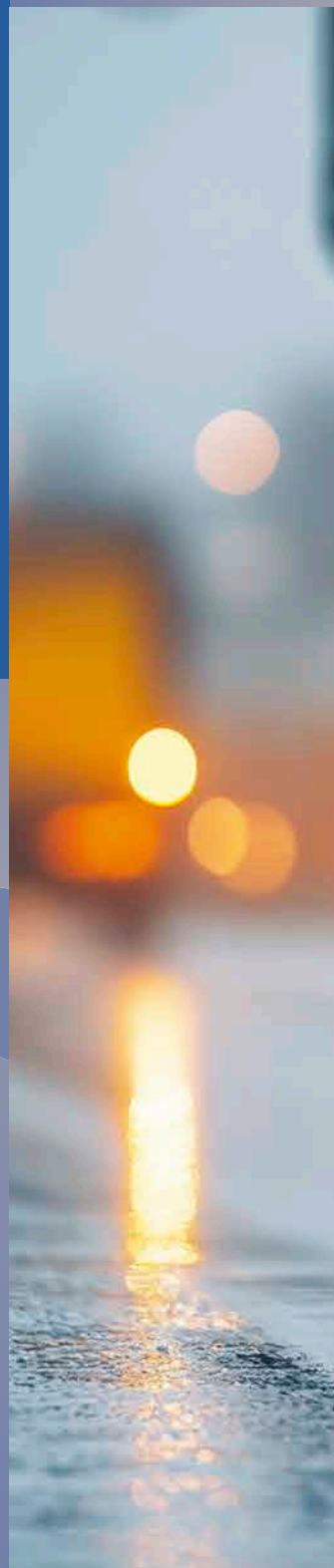



2-FUNCTION LED MARKER LAMP / DSL-570 SERIES

TECHNICAL SPECIFICATIONS

Functions: Front Position, Rear Position
Operating Voltage: 10-30V DC
Consumption: (12V/24V) 0,4W / 0,8W
Type of Protection: IP67

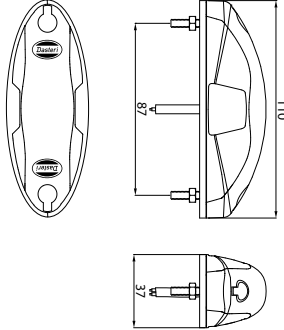

ECE APPROVED EMC APPROVED

FOR SURFACE MOUNTING

REF. No
DSL570-0.067 With 1m cable
DSL571-0.067 With 2-pole connector

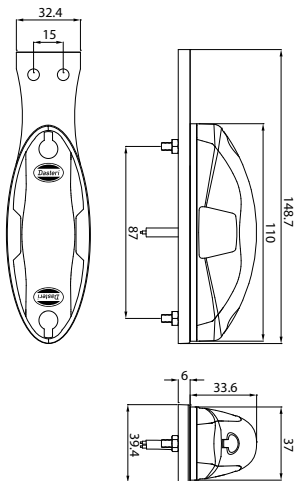

ECE APPROVED EMC APPROVED

WITH BRACKET

REF. No
DSL570-1.067 With 1m cable
DSL571-1.067 With 2-pole connector

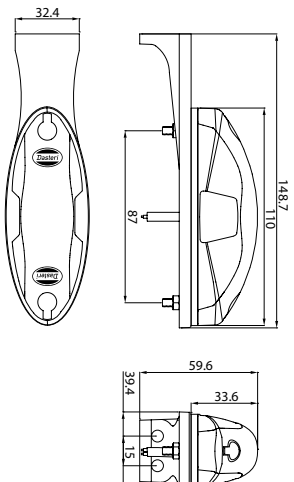

ECE APPROVED EMC APPROVED

WITH ANGLED BRACKET

REF. No
DSL570-2.067 With 1m cable
DSL571-2.067 With 2-pole connector

3-FUNCTION LED MARKER LAMP / DSL-570 SERIES

TECHNICAL SPECIFICATIONS

Functions: Front Position, Rear Position, Side Marker
Operating Voltage: 10-30V DC
Consumption: (12V/24V) 0,4W / 0,8W
Type of Protection: IP67

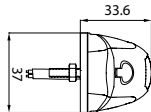
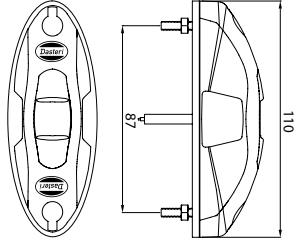

ECE APPROVED

EMC APPROVED

FOR SURFACE MOUNTING

REF. No

DSL570-0.567 With 1m cable

DSL571-0.567 With 2-pole connector

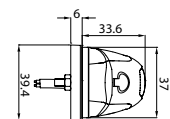
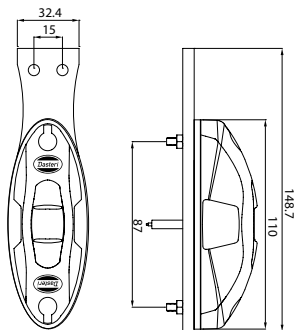

ECE APPROVED

EMC APPROVED

WITH BRACKET

REF. No

DSL570-1.567 With 1m cable

DSL571-1.567 With 2-pole connector

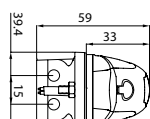
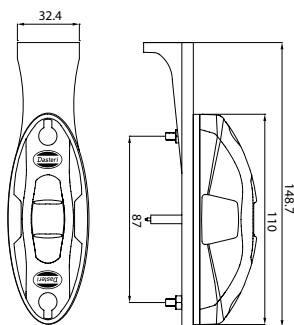

ECE APPROVED

EMC APPROVED

WITH ANGLED BRACKET

REF. No

DSL570-2.567 With 1m cable

DSL571-2.567 With 2-pole connector

2-FUNCTION REAR LED LAMP 10-30V



REF. No

DSL-605.07

Clear Color

TECHNICAL SPECIFICATIONS

Functions: Tail, Direction Indicator

Operating Voltage: 10-30V DC

Consumption: Tail 1W, DI 1,8W

Type of Protection: IP67

Cable/Connector: 1000 mm cable

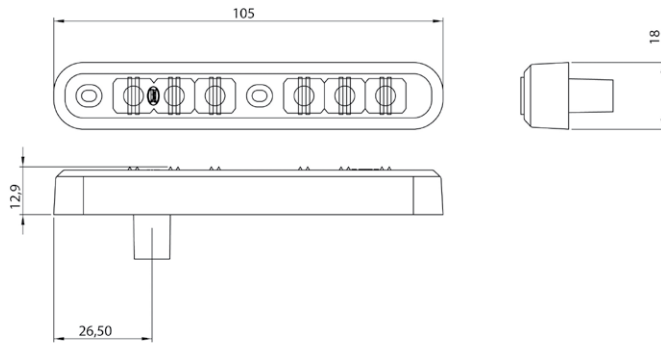

ECE APPROVED

EMC APPROVED

FRONT & REAR LED POSITION MARKER LAMP



REF. No

DSL-580.067

Red - Clear

TECHNICAL SPECIFICATIONS

Functions: Front Position, Rear Position

Operating Voltage: 10 - 30V DC

Consumption: 1,4W

0,7W/1,4W for single-function

Type of Protection: IP67

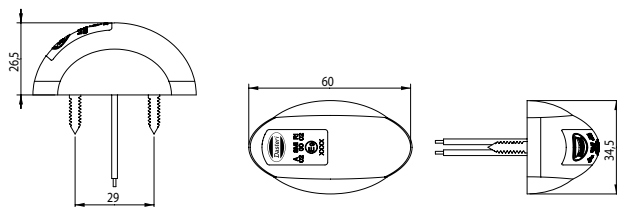

ECE APPROVED

EMC APPROVED

2-FUNCTION LED MARKER LAMP

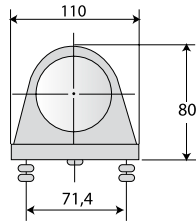

REF. No

DSL-615.367	Red - Clear lens
DSL-615.365	Red - Amber lens
DSL-P-615.06	Spare Unit with 3 LEDs, Red
DSL-P-615.07	Spare Unit with 3 LEDs, Clear
DSL-P-615.05	Spare Unit with 3 LEDs, Amber

TECHNICAL SPECIFICATIONS

Functions:	Front Position, Rear Position
Operating Voltage:	12 or 24V DC
Consumption:	1W
Type of Protection:	IP67

At the end of the reference number, add /12 for 12V or /24 for 24V version.

2-FUNCTION LED MARKER LAMP

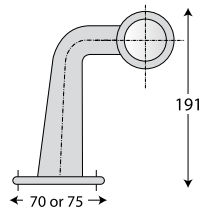

REF. No

DSL-610.367	Red - Clear lens
DSL-610.365	Red - Amber lens
DSL-P-610.06	Spare Unit with 3 LEDs, Red
DSL-P-610.07	Spare Unit with 3 LEDs, Clear
DSL-P-610.05	Spare Unit with 3 LEDs, Amber

TECHNICAL SPECIFICATIONS

Functions:	Front Position, Rear Position
Operating Voltage:	12 or 24V DC
Consumption:	1W
Type of Protection:	IP67

At the end of the reference number, add /12 for 12V or /24 for 24V version. Then only for the Lamps add R for Right or L for Left version.

ECE APPROVED

2-FUNCTION LED MARKER LAMP

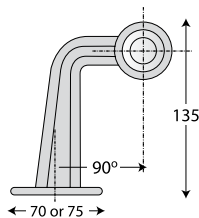

REF. No

DSL-611.367	Red - Clear lens
DSL-611.365	Red - Amber lens
DSL-P-610.06	Spare Unit with 3 LEDs, Red
DSL-P-610.07	Spare Unit with 3 LEDs, Clear
DSL-P-610.05	Spare Unit with 3 LEDs, Amber

TECHNICAL SPECIFICATIONS

Functions:	Front Position, Rear Position
Operating Voltage:	12 or 24V DC
Consumption:	1W
Type of Protection:	IP67

At the end of the reference number, add /12 for 12V or /24 for 24V version. Then only for the Lamps add R for Right or L for Left version.

ECE APPROVED

2-FUNCTION LED MARKER LAMP

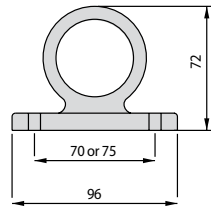

REF. No

DSL-616.367	Red - Clear lens	Add /12 for 12V version or /24 for 24V version
DSL-616.365	Red - Amber lens	
DSL-P-610.06	Spare Unit with 3 LEDs, Red	
DSL-P-610.07	Spare Unit with 3 LEDs, Clear	
DSL-P-610.05	Spare Unit with 3 LEDs, Amber	

TECHNICAL SPECIFICATIONS

Functions:	Front Position, Rear Position
Operating Voltage:	12V or 24V DC
Consumption:	1W
Type of Protection:	IP67

2-FUNCTION LED MARKER LAMP

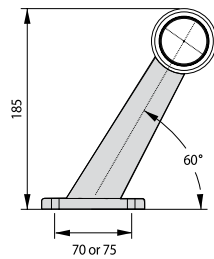

REF. No

DSL-613.367	Red - Clear lens	Add /12 for 12V version or /24 for 24V version
DSL-613.365	Red - Amber lens	
DSL-P-610.06	Spare Unit with 3 LEDs, Red	
DSL-P-610.07	Spare Unit with 3 LEDs, Clear	
DSL-P-610.05	Spare Unit with 3 LEDs, Amber	

TECHNICAL SPECIFICATIONS

Functions:	Front Position, Rear Position
Operating Voltage:	12V or 24V DC
Consumption:	1W
Type of Protection:	IP67

ECE APPROVED

2-FUNCTION LED MARKER LAMP

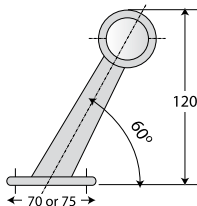

REF. No

DSL-612.367	Red - Clear lens	Add /12 for 12V version or /24 for 24V version
DSL-612.365	Red - Amber lens	
DSL-P-610.06	Spare Unit with 3 LEDs, Red	
DSL-P-610.07	Spare Unit with 3 LEDs, Clear	
DSL-P-610.05	Spare Unit with 3 LEDs, Amber	

TECHNICAL SPECIFICATIONS

Functions:	Front Position, Rear Position
Operating Voltage:	12V or 24V DC
Consumption:	1W
Type of Protection:	IP67

ECE APPROVED

3-FUNCTION LED MARKER LAMP

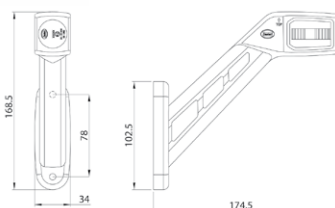

REF. No

DSL-620S.567/12L	Left, 12 Volt	Add /12 for 12V version or /24 for 24V version
DSL-620S.567/12R	Right, 12 Volt	
DSL-620S.567/24L	Left, 24 Volt	
DSL-620S.567/24R	Right, 24 Volt	

TECHNICAL SPECIFICATIONS

Functions:	Front Position, Side Marker, Rear Position
Operating Voltage:	12 or 24V DC
Consumption:	1,2W
Type of Protection:	IP67

ECE APPROVED

3-FUNCTION LED MARKER LAMP

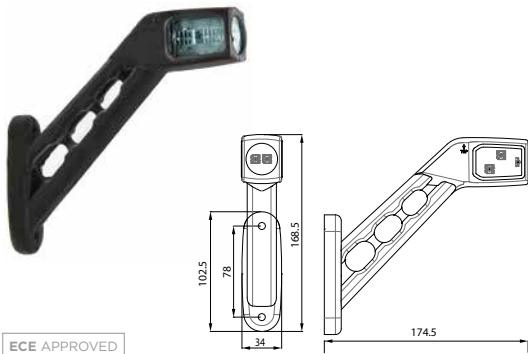

REF. No

DSL-620.567/12L	Left, 12 Volt
DSL-620.567/12R	Right, 12 Volt
DSL-620.567/24L	Left, 24 Volt
DSL-620.567/24R	Right, 24 Volt
L-622.567/12	12 Volt Spare LED Unit
L-622.567/24	24 Volt Spare LED Unit

TECHNICAL SPECIFICATIONS

Functions:	Front Position, Rear Position, Side Marker
Operating Voltage:	12 or 24V DC
Consumption:	1,2W
Type of Protection:	IP67

3-FUNCTION LED MARKER LAMP



REF. No

DSL-622S.567/12L	Left, 12 Volt
DSL-622S.567/12R	Right, 12 Volt
DSL-622S.567/24L	Left, 24 Volt
DSL-622S.567/24R	Right, 24 Volt

TECHNICAL SPECIFICATIONS

Functions:	Front Position, Side Marker, Rear Position
Operating Voltage:	12 or 24V DC
Consumption:	1,2W
Type of Protection:	IP67

3-FUNCTION LED MARKER LAMP

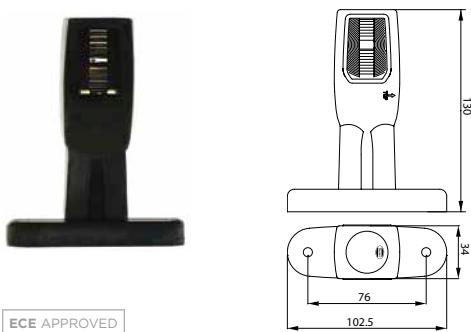

REF. No

DSL-622.567/12	12 Volt
DSL-622.567/24	24 Volt
L-622.567/12	12 Volt Spare Unit
L-622.567/24	24 Volt Spare Unit

TECHNICAL SPECIFICATIONS

Functions:	Front Position, Side Marker, Rear Position
Operating Voltage:	12 or 24V DC
Consumption:	1,2W
Type of Protection:	IP67

3-FUNCTION LED MARKER LAMP

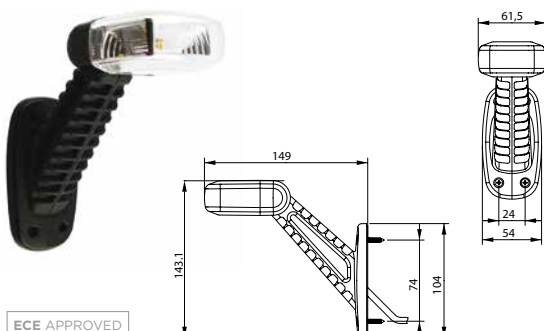

REF. No

DSL-630V567R	Right for vertical mounting
DSL-630V567L	Left for vertical mounting
DSL-630H567R	Right for horizontal mounting
DSL-630H567L	Left for horizontal mounting

TECHNICAL SPECIFICATIONS

Functions:	Front Position, Rear Position, Side Marker
Operating Voltage:	10-30V DC
Consumption:	0,8W
Type of Protection:	IP67

3-FUNCTION MARKER LAMP

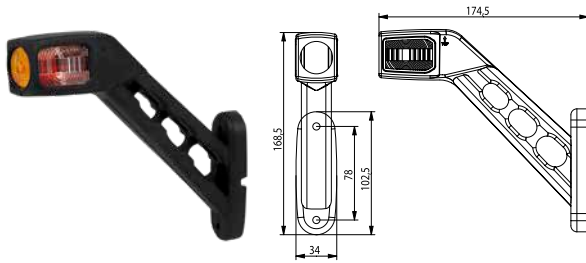

ECE APPROVED

REF. No

620.0567

With 1m cable

620.0567TS

With click-in system and 1m cable

P-620.0567

Spare lens, Red - Clear - Amber

TECHNICAL SPECIFICATIONS

Functions: Front Position, Rear Position, Side Marker
Operating Voltage: 12 or 24V DC
Consumption: 1x4W
Type of Protection: IP67

3-FUNCTION MARKER LAMP



ECE APPROVED

REF. No

622.567

Red - Clear - Amber lens

P-620.0567

Spare lens

TECHNICAL SPECIFICATIONS

Functions: Front Position, Rear Position, Side Marker
Operating Voltage: 12 or 24V DC
Consumption: 1x4W
Type of Protection: IP67

2-FUNCTION MARKER LAMP

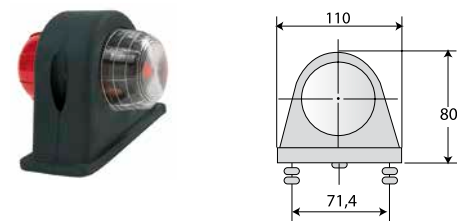

ECE APPROVED

REF. No

615.067

Red - Clear lens

615.065

Red - Amber lens

P-615.06

Spare lens, Red

P-615.07

Spare lens, Clear

P-615.05

Spare lens, Amber

TECHNICAL SPECIFICATIONS

Functions: Front Position, Rear Position
Operating Voltage: 12 or 24V DC
Consumption: 1x5W
Type of Protection: IP67

2-FUNCTION MARKER LAMP

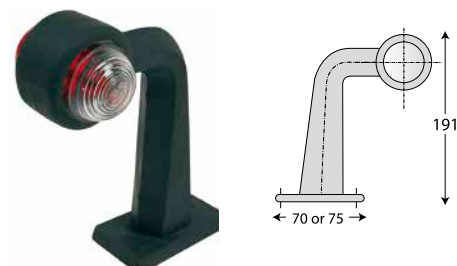

ECE APPROVED

REF. No

610.067

Red - Clear lens

610.065

Red - Amber lens

P-610.06

Spare lens, Red

P-610.07

Spare lens, Clear

P-610.05

Spare lens, Amber

TECHNICAL SPECIFICATIONS

Functions: Front Position, Rear Position
Operating Voltage: 12 or 24V DC
Consumption: 1x5W
Type of Protection: IP67

2-FUNCTION MARKER LAMP

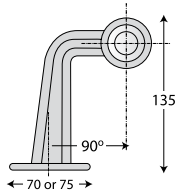

REF. No	
611.067	Red - Clear lens
611.065	Red - Amber lens
P-610.06	Spare lens, Red
P-610.07	Spare lens, Clear
P-610.05	Spare lens, Amber

TECHNICAL SPECIFICATIONS

Functions:	Front Position, Rear Position
Operating Voltage:	12 or 24V DC
Consumption:	1x5W
Type of Protection:	IP67

ECE APPROVED

2-FUNCTION MARKER LAMP

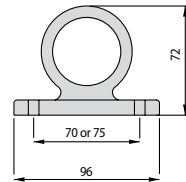

REF. No	
616.067	Red - Clear lens
616.065	Red - Amber lens
P-610.06	Spare lens, Red
P-610.07	Spare lens, Clear
P-610.05	Spare lens, Amber

TECHNICAL SPECIFICATIONS

Functions:	Front Position, Rear Position
Operating Voltage:	12 or 24V DC
Consumption:	1x5W
Type of Protection:	IP67

ECE APPROVED

2-FUNCTION MARKER LAMP

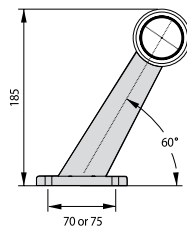

REF. No	
613.067	Red - Clear lens
613.065	Red - Amber lens
P-610.06	Spare lens, Red
P-610.07	Spare lens, Clear
P-610.05	Spare lens, Amber

TECHNICAL SPECIFICATIONS

Functions:	Front Position, Rear Position
Operating Voltage:	12 or 24V DC
Consumption:	1x5W
Type of Protection:	IP67

ECE APPROVED

2-FUNCTION MARKER LAMP

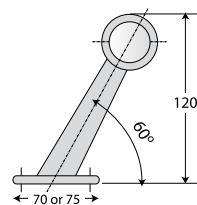

REF. No	
612.067	Red - Clear lens
612.065	Red - Amber lens
P-610.06	Spare lens, Red
P-610.07	Spare lens, Clear
P-610.05	Spare lens, Amber

TECHNICAL SPECIFICATIONS

Functions:	Front Position, Rear Position
Operating Voltage:	12 or 24V DC
Consumption:	1x5W
Type of Protection:	IP67

ECE APPROVED

2-FUNCTION MARKER LAMP / 512 SERIES

TECHNICAL SPECIFICATIONS

Functions: Front Position, Rear Position
Consumption: 1x5W / 2x5w

Operating Voltage: 12 or 24V DC
Type of Protection: IP67



ECE APPROVED

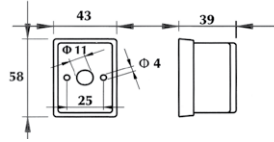

FOR SURFACE MOUNTING

REF. No	
512-0.067	Red - Clear lens
512-0.05	Amber lens
512-0.06	Red lens



ECE APPROVED

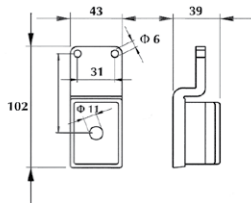

WITH BRACKET

REF. No	
512-1.067	Red - Clear lens
512-1.05	Amber lens
512-1.06	Red lens



ECE APPROVED

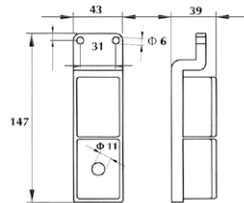

DOUBLE WITH BRACKET

REF. No	
512-2.067	Red - Clear lens
512-2.05	Amber lens
512-2.06	Red lens

SPARE LENS

REF. No	
P-512.067	Spare lens, Red - Clear
P-512.05	Spare lens, Amber
P-512.06	Spare lens, Red

2-FUNCTION MARKER LAMP / 513 SERIES

TECHNICAL SPECIFICATIONS

Functions: Front Position, Rear Position
Consumption: 1x5W

Operating Voltage: 12 or 24V DC
Type of Protection: IP67



ECE APPROVED

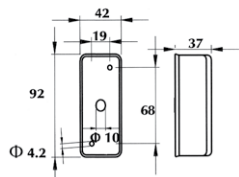

FOR SURFACE MOUNTING

REF. No	
513-0.067	Red - Clear lens
513-0.05	Amber lens
513-0.06	Red lens



ECE APPROVED

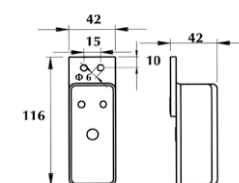

WITH BRACKET

REF. No	
513-1.067	Red - Clear lens
513-1.05	Amber lens
513-1.06	Red lens



ECE APPROVED

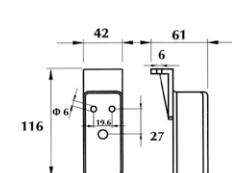

WITH ANGLED BRACKET

REF. No	
513-2.067	Red - Clear lens
513-2.05	Amber lens
513-2.06	Red lens

SPARE LENS

REF. No	
P-513.067	Spare lens, Red - Clear
P-513.05	Spare lens, Amber
P-513.06	Spare lens, Red

LED SIDE MARKER / DI LAMP

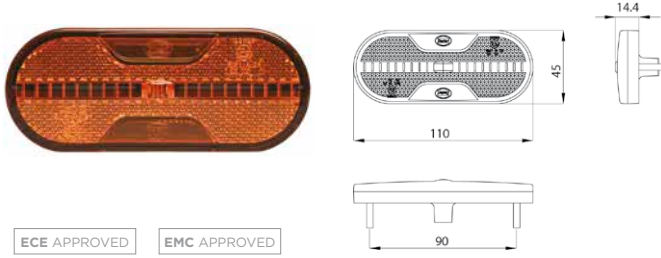

ECE APPROVED EMC APPROVED

REF. No
DSL-640-0.05

TECHNICAL SPECIFICATIONS

Functions: Side Marker, DI, Reflex Reflector
Operating Voltage: 10-30V DC
Consumption: 0,6W (12V), 1,2W (24V)
Type of Protection: IP67
Cable/Connector: 500 mm cable

For dual usage (Sidemarker/Direction Indicator) module box DSL-MDI.S is required

LED SIDE MARKER / DI LAMP

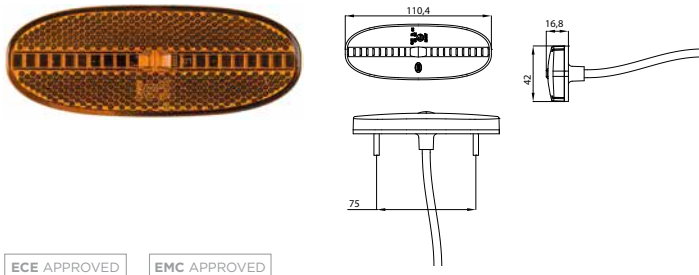

ECE APPROVED EMC APPROVED

REF. No
DSL-650.05
DSL-650.05TS

Sidemarker / D.I.
With Click-in connector
DSL-MDI Module box (required, see Wiring Kits & Various Parts category)

TECHNICAL SPECIFICATIONS

Functions: Direction Indicator, Side Marker, Reflex Reflector
Operating Voltage: 24V
Consumption: 2.18W
Type of Protection: IP67

LED SIDE MARKER LAMP

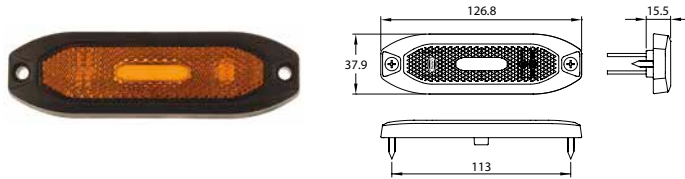

ECE APPROVED EMC APPROVED SAE DOT APPROVED

REF. No
DSL-590.05 With Reflex Reflector

TECHNICAL SPECIFICATIONS

Functions: Sidemarker, Reflex Reflector
Operating Voltage: 10-30V DC
Consumption: 1.1W
Type of Protection: IP67

LED SIDE MARKER LAMP

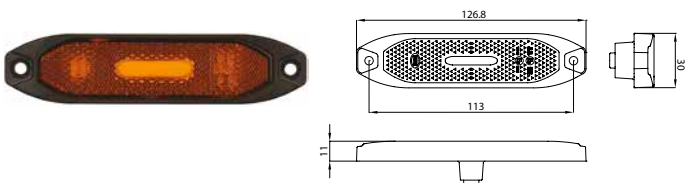

ECE APPROVED EMC APPROVED SAE DOT APPROVED

REF. No
DSL-595-0.05 With Reflex Reflector

TECHNICAL SPECIFICATIONS

Functions: Sidemarker, Reflex Reflector
Operating Voltage: 10-30V DC
Consumption: 1.1W
Type of Protection: IP67

LED SIDE MARKER LAMP

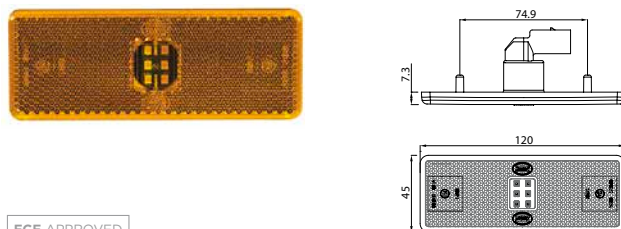

ECE APPROVED

REF. No
535-0.05 With Reflex Reflector

TECHNICAL SPECIFICATIONS

Functions: Side Marker, Reflex Reflector
Operating Voltage: 9-33V DC
Consumption: 1W
Type of Protection: IP67

LED SIDE MARKER LAMP



ECE APPROVED

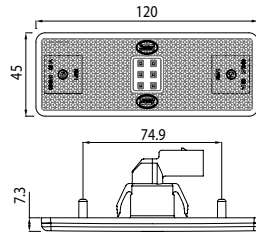

REF. No
536-0.05

With Reflex Reflector and Angled Base

TECHNICAL SPECIFICATIONS

Functions: Side Marker, Reflex Reflector
Operating Voltage: 9-33V DC
Consumption: 1W
Type of Protection: IP67

LED SIDE MARKER LAMP / 560L LONG VERSION



ECE APPROVED

EMC APPROVED

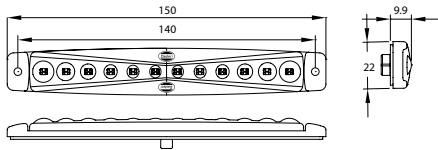

REF. No
560L-0.05/12
560L-0.05/24

12V For Surface Mounting
24V For Surface Mounting

TECHNICAL SPECIFICATIONS

Functions: Side Marker, Reflex Reflector
Operating Voltage: 12 or 24V
Consumption: 12V:1.5W 24V:0.9W
Type of Protection: IP67

LED SIDE MARKER LAMP / 560 SERIES

TECHNICAL SPECIFICATIONS

Functions: Side Marker, Reflex Reflector
Operating Voltage: 12 or 24V DC
Consumption: 0,5W
Type of Protection: IP67



ECE APPROVED

EMC APPROVED

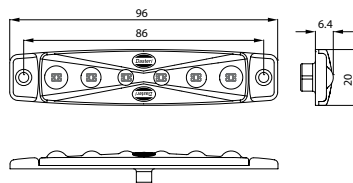

FOR SURFACE MOUNTING

REF. No
560-0.05/12 12 Volt
560-0.05/24 24 Volt



ECE APPROVED

EMC APPROVED

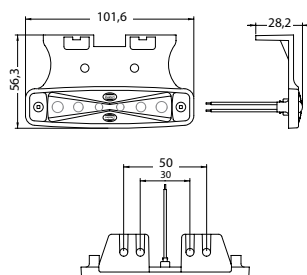

WITH ANGLED BRACKET

REF. No
560-2.05/12 12 Volt
560-2.05/24 24 Volt

LED SIDE MARKER LAMP



ECE APPROVED

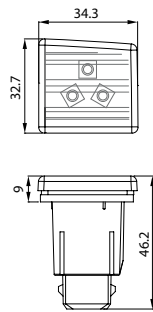

REF. No

DSL-3040/24

For SETRA buses

TECHNICAL SPECIFICATIONS

Functions: Side Marker
Operating Voltage: 24V DC
Consumption: 1,3W
Type of Protection: IP67

LED SIDE MARKER LAMP / 550 SERIES

TECHNICAL SPECIFICATIONS

Functions: Side Marker
Operating Voltage: 9-33V DC
Consumption: 1W
Type of Protection: IP67



ECE APPROVED

EMC APPROVED

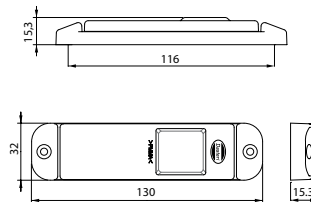

FOR SURFACE MOUNTING

REF. No

550-0.05

With 1m cable

550-0.05TS

With click-in system and 0,5m cable

550-0.05TS15

With click-in system and 1,5m cable

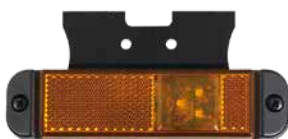

ECE APPROVED

EMC APPROVED

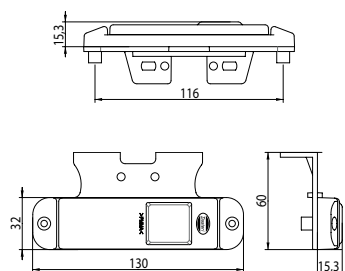

WITH ANGLED BRACKET

REF. No

550-2.05

With 1m cable



ECE APPROVED

EMC APPROVED

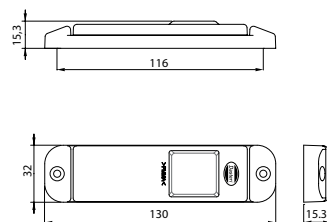

WITH 30CM CABLE AND CONNECTOR

REF. No

550-0.05D

With 30cm cable for truck DAF-XF

LED SIDE MARKER LAMP / 542 SERIES

TECHNICAL SPECIFICATIONS

Functions: Side Marker, Reflex Reflector
Operating Voltage: 24V DC
Consumption: 0,5W
Type of Protection: IP67

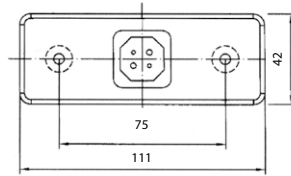

FOR SURFACE MOUNTING

REF. No
542-0.05/24 With reflex reflector and 20cm cable
542E0-0.05 Eco Line, 10-30V, with Cable
542E1-0.05 Eco Line, 10-30V, with 2-pole Connector

ECE APPROVED EMC APPROVED

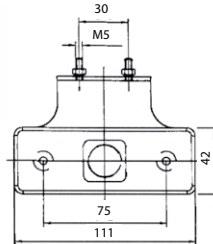

WITH ANGLED BRACKET

REF. No
542-2.05/24 With reflex reflector and 20cm cable
542E0-2.05 Eco Line, 10-30V, with Cable
542E1-2.05 Eco Line, 10-30V, with 2-pole Connector

ECE APPROVED EMC APPROVED

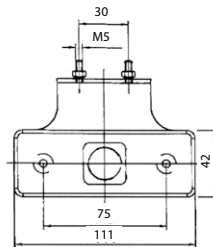
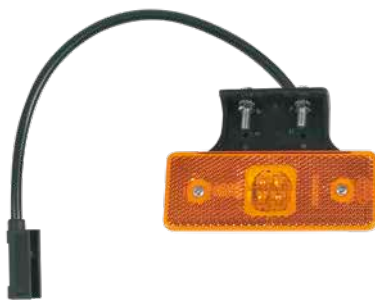

WITH ANGLED BRACKET AND CLICK-IN CONNECTOR

REF. No
542-2.05TS With reflex reflector and click-in cable connector

ECE APPROVED EMC APPROVED

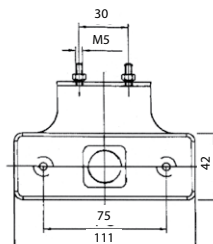

WITH SPECIAL ANGLED BASE

REF. No
542-P2.05/12 12 Volt With reflex reflector and 20cm cable
542-P2.05/24 24 Volt With reflex reflector and 20cm cable

ECE APPROVED EMC APPROVED

LED SIDE MARKER LAMP / 530L SERIES

TECHNICAL SPECIFICATIONS

Functions: Side Marker, Reflex Reflector
Operating Voltage: 12 or 24V DC
Consumption: 0,5W
Type of Protection: IP67

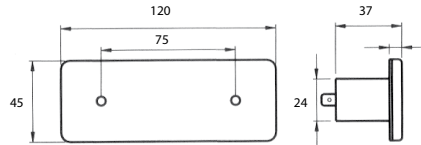

FOR SURFACE MOUNTING

REF. No

530L-0.05/12 With reflex reflector and 20cm cable, 12 Volt

530L-0.05/24 With reflex reflector and 20cm cable, 24 Volt

ECE APPROVED

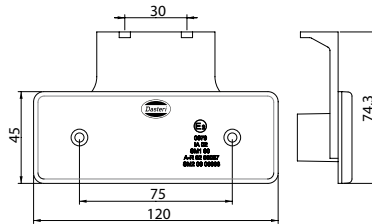

WITH ANGLED BRACKET

REF. No

530L-2.05/12 With reflex reflector and 20cm cable, 12 Volt

530L-2.05/24 With reflex reflector and 20cm cable, 24 Volt

ECE APPROVED

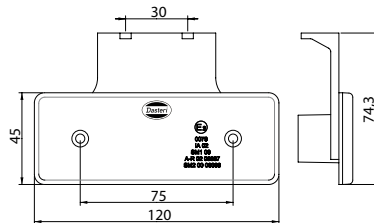

WITH ANGLED BRACKET AND CLICK-IN CONNECTOR

REF. No

530L-2.05TS/12 12V With reflex reflector and click-in cable connector

530L-2.05TS/24 With reflex reflector and click-in cable connector

ECE APPROVED

MARKER LAMPS

LED SIDE MARKER LAMP



REF. No

541-0.05/24

With reflex reflector and connector

541-2.05/24

With reflex reflector and angled bracket

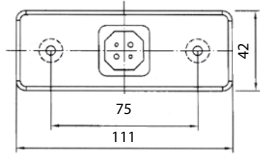

TECHNICAL SPECIFICATIONS

Functions: Side Marker, Reflex Reflector

Operating Voltage: 24V DC

Consumption: 0,5W

Type of Protection: IP67

ECE APPROVED

LED SIDE MARKER LAMP / 540 SERIES

TECHNICAL SPECIFICATIONS

Functions: Side Marker, Reflex Reflector

Operating Voltage: 12 or 24V DC

Consumption: 0,5W

Type of Protection: IP67

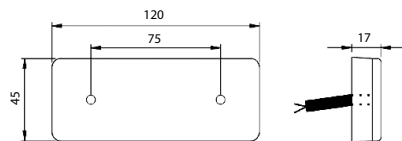

FOR SURFACE MOUNTING

REF. No

540-0.05/12

With reflex reflector and 20cm cable, 12 Volt

540-0.05/24

With reflex reflector and 20cm cable, 24 Volt

ECE APPROVED

WITH ANGLED BRACKET

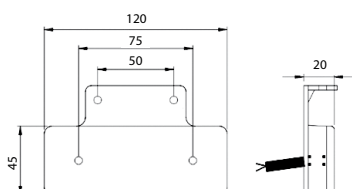

REF. No

540-2.05/12

With reflex reflector and 20cm cable, 12 Volt

540-2.05/24

With reflex reflector and 20cm cable, 24 Volt

ECE APPROVED

LED SIDE MARKER LAMP / 543 SERIES

TECHNICAL SPECIFICATIONS

Functions: Side Marker, Reflex Reflector
Operating Voltage: 12 or 24V DC
Consumption: 0,5W
Type of Protection: IP67

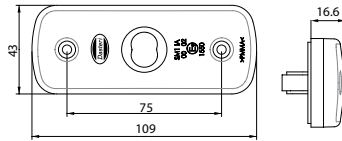

FOR SURFACE MOUNTING

REF. No
543-0.05C With Reflex Reflector

ECE APPROVED

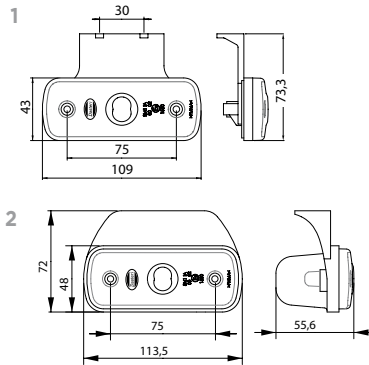

WITH ANGLED BRACKET VARIATIONS

REF. No
543-2.05C With angled bracket 1
543-P2.05C With angled bracket 2
543-P2.05TS With angled bracket 2 and click-in cable

ECE APPROVED

LED SIDE MARKER LAMP

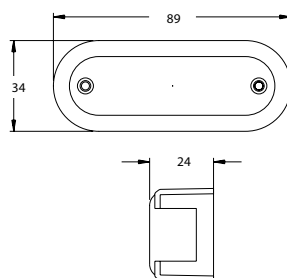

REF. No
DSL-24.305 With clear lens and amber LEDs

TECHNICAL SPECIFICATIONS

Functions: Side Marker
Operating Voltage: 24V DC
Consumption: 0,5W
Type of Protection: IP67

ECE APPROVED

LED SIDE MARKER LAMP

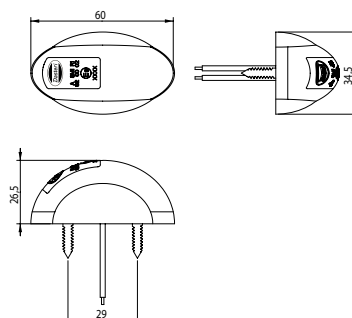

REF. No
DSL-580.05 Amber

TECHNICAL SPECIFICATIONS

Functions: Side Marker
Operating Voltage: 10-30V DC
Consumption: (12V/24V) 0,7W/1,4W
Type of Protection: IP67

ECE APPROVED

SIDE MARKER LAMP / 531 SERIES

TECHNICAL SPECIFICATIONS

Functions: Side Marker, Reflex Reflector
Operating Voltage: 12 or 24V DC
Consumption: 1x3W

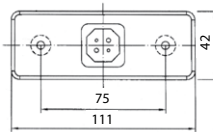

FOR SURFACE MOUNTING

REF. No
531-0.05 With Reflex Reflector

ECE APPROVED

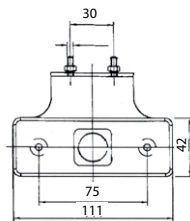

WITH ANGLED BRACKET

REF. No
532-2.05 With Reflex Reflector

ECE APPROVED

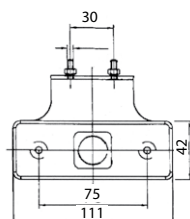

WITH ANGLED BRACKET AND CLICK-IN CONNECTOR

REF. No
532-2.05TS With Reflex Reflector

ECE APPROVED

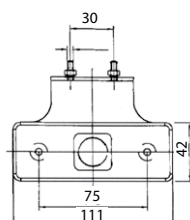

WITH ANGLED BRACKET

REF. No
531-P2.05 With angled plastic base

ECE APPROVED

SIDE MARKER LAMP / 533 SERIES

TECHNICAL SPECIFICATIONS

Functions: Side Marker, Reflex Reflector
Operating Voltage: 12 or 24V DC
Consumption: 1x3W



FOR SURFACE MOUNTING

REF. No
533-0.05 With Reflex Reflector

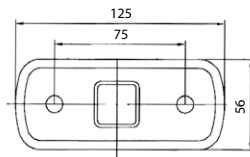

ECE APPROVED



WITH BRACKET

REF. No
534-2.05 With Reflex Reflector

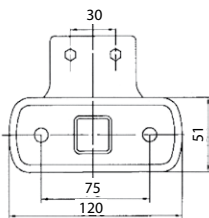

ECE APPROVED



WITH ANGLED BRACKET AND CLICK-IN CONNECTOR

REF. No
534-2.05TS With Reflex Reflector

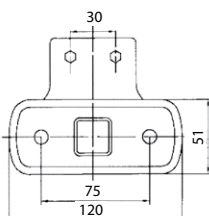

ECE APPROVED

SIDE MARKER LAMP / 520 SERIES

TECHNICAL SPECIFICATIONS

Functions: Side Marker, Reflex Reflector
Operating Voltage: 12 or 24V DC
Consumption: 1x3W



FOR SURFACE MOUNTING

REF. No
520-0

With Reflex Reflector

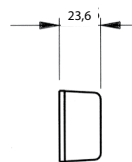
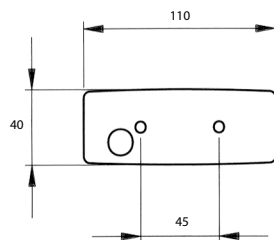

ECE APPROVED



WITH BRACKET

REF. No
520-1

With Reflex Reflector

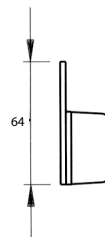
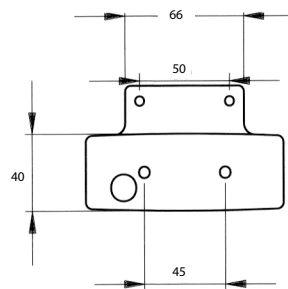

ECE APPROVED



WITH ANGLED BRACKET

REF. No
520-2
P-520.05

With Reflex Reflector
 Spare lens, Amber

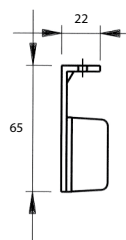
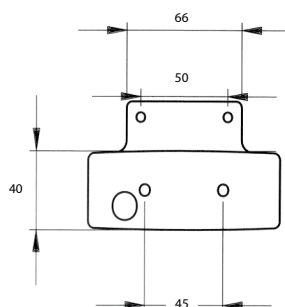

ECE APPROVED

SIDE MARKER LAMP / 530 SERIES

TECHNICAL SPECIFICATIONS

Functions: Side Marker, Reflex Reflector
Operating Voltage: 12 or 24V DC
Consumption: 1x3W



FOR SURFACE MOUNTING

REF. No
530-0.05

With Reflex Reflector

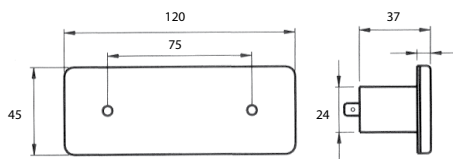

ECE APPROVED



WITH ANGLED BRACKET

REF. No
530-2.05

With Reflex Reflector

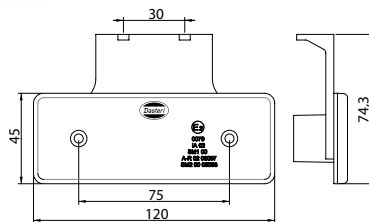

ECE APPROVED

SIDE MARKER LAMP



REF. No
8080/31.05
P-8080-31.05

Side marker lamp
 Spare lens, amber

TECHNICAL SPECIFICATIONS

Functions: Side Marker
Operating Voltage: 12 or 24V DC
Consumption: 1x5W or 1x18W

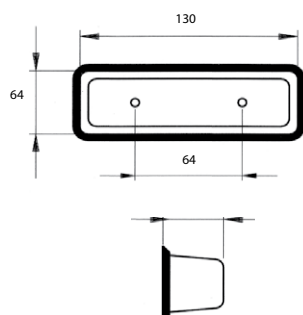

SIDE MARKER LAMP

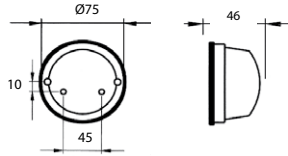

REF. No
133.05 Side marker lamp
P-133.05 Spare lens, amber

TECHNICAL SPECIFICATIONS

Functions: Side Marker
Operating Voltage: 12 or 24V DC
Consumption: 1x5W

SIDE MARKER LAMP

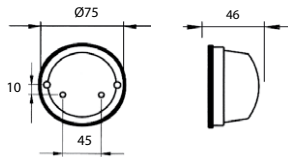

REF. No
8080/27 Side marker lamp
8080/28 Green marker lamp
8080/28.08 Blue marker lamp
P-8080-27 Spare lens, amber
P-8080-28 Spare lens, green
P-8080-28.08 Spare lens, blue

TECHNICAL SPECIFICATIONS

Functions: Side Marker
Operating Voltage: 12 or 24V DC
Consumption: 1x5W

SIDE MARKER LAMP

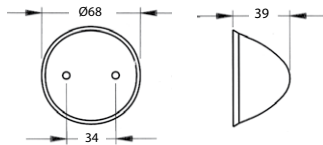

REF. No
8080-51A.05 Side marker lamp
P-8080-51A.05 Spare lens, amber

TECHNICAL SPECIFICATIONS

Functions: Side Marker
Operating Voltage: 12 or 24V DC
Consumption: 1x5W

SIDE MARKER LAMP

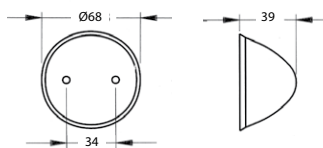

REF. No
8080-51.05 Side marker lamp
P-8080-51.05 Spare lens, amber

TECHNICAL SPECIFICATIONS

Functions: Side Marker
Operating Voltage: 12 or 24V DC
Consumption: 1x5W

SIDE MARKER LAMP

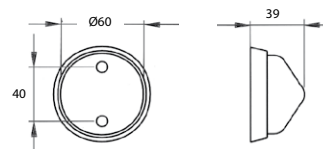

REF. No
8080/29.05 Amber
8080/29.08 Blue
8080/29.09 Green
P-8080-29.05 Spare lens, amber
P-8080-29.08 Spare lens, blue
P-8080-29.09 Spare lens, green

TECHNICAL SPECIFICATIONS

Functions: Side Marker
Operating Voltage: 12 or 24V DC
Consumption: 1x5W

MARKER LAMPS

LED FRONT MARKER LAMP

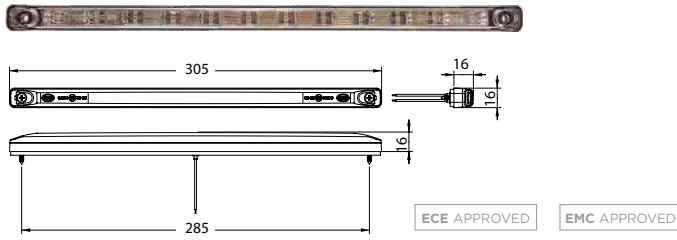

REF. No
DSL-12FT/12 12 Volt
DSL-12FT/24 24 Volt

TECHNICAL SPECIFICATIONS
Operating Voltage: 12 or 24V DC
Consumption: (12/24V) 0,6W/0,6W
Type of Protection: IP67

LED FRONT MARKER LAMP

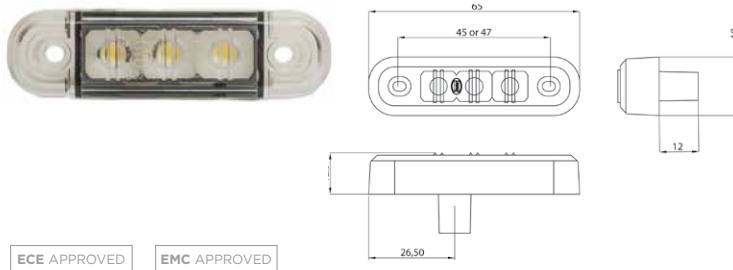

REF. No
DSL-601.07 Clear Color

TECHNICAL SPECIFICATIONS
Functions: Front Position
Operating Voltage: 10-30V DC
Consumption: 0,8W
Type of Protection: IP67
Cable/Connector: 1000 mm cable

LED FRONT MARKER LAMP / 560 SERIES



REF. No
560-0.07/12 12 Volt
560-0.07/24 24 Volt

TECHNICAL SPECIFICATIONS
Functions: Front Marker, Reflex Reflector
Operating Voltage: 12 or 24V DC
Consumption: 0,5W
Type of Protection: IP67

LED FRONT MARKER LAMP / 560L LONG VERSION

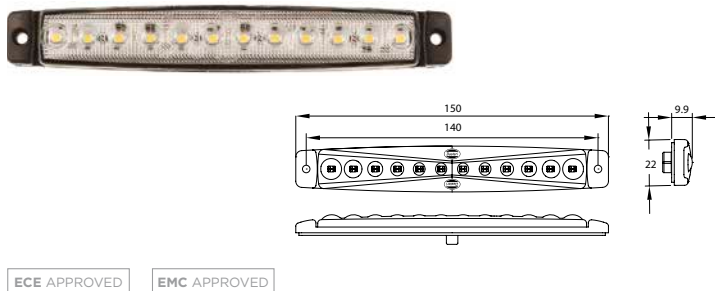

REF. No
560L-0.07/12 12V For Surface Mounting
560L-0.07/24 24V For Surface Mounting

TECHNICAL SPECIFICATIONS
Functions: Front Marker
Operating Voltage: 12 or 24V
Consumption: 12V: 0.7W 24V: 0.8W
Type of Protection: IP67

LED FRONT MARKER LAMP

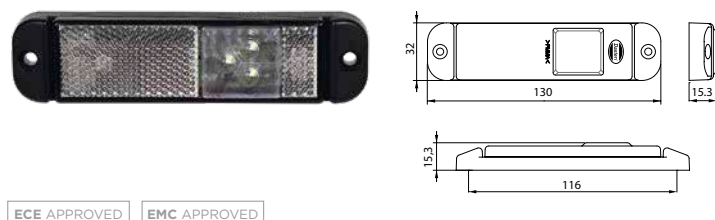

REF. No
550-0.07 With 1m cable
550-0.07TS With click-in system & 0,5m cable
550-0.07TS15 With click-in system & 1,5m cable

TECHNICAL SPECIFICATIONS
Functions: Front Marker, Reflex Reflector
Operating Voltage: 10-30V DC
Consumption: 0,5W
Type of Protection: IP67

LED FRONT POSITION MARKER LAMP

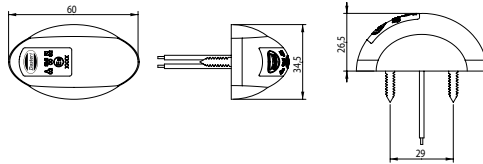

ECE APPROVED EMC APPROVED

REF. No
DSL-580.07 Clear

TECHNICAL SPECIFICATIONS

Operating Voltage: 10-30V DC
Consumption: (12/24V) 0,7W/1,4W
Type of Protection: IP67

LED FRONT MARKER LAMP

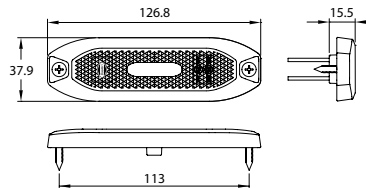

ECE APPROVED EMC APPROVED SAE DOT APPROVED

REF. No
DSL-590.07 With Reflex Reflector

TECHNICAL SPECIFICATIONS

Functions: Front Marker, Reflex Reflector
Operating Voltage: 10-30V
Consumption: 0,9W
Type of Protection: IP67

LED FRONT MARKER LAMP

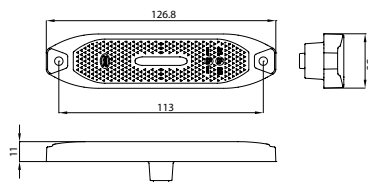

ECE APPROVED EMC APPROVED

REF. No
DSL-595-0.07 With Reflex Reflector

TECHNICAL SPECIFICATIONS

Functions: Front Marker, Reflex Reflector
Operating Voltage: 10-30V
Consumption: 0,9W
Type of Protection: IP67

LED FRONT MARKER LAMP

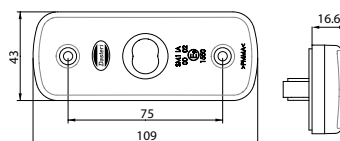

ECE APPROVED

REF. No
543-0.07C/12 12 Volt
543-0.07C/24 24 Volt

TECHNICAL SPECIFICATIONS

Functions: Front Marker, Reflex Reflector
Operating Voltage: 12 or 24V DC
Consumption: 0,5W
Type of Protection: IP67

MARKER LAMPS

LED FRONT MARKER LAMP



ECE APPROVED

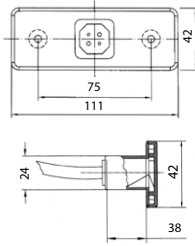

REF. No

- 542-0.07/24** 24 Volt, with 20cm, cable
- 542E0-0.07** Economy Line, 10-30V, cable
- 542E1-0.07** Economy Line, 10-30V, With 2-pole Connector

TECHNICAL SPECIFICATIONS

- Functions:** Front Marker
- Operating Voltage:** 24V DC
- Consumption:** 0,5W
- Type of Protection:** IP67

LED FRONT MARKER LAMP



ECE APPROVED

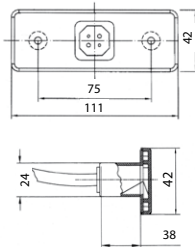

REF. No

- 542-0.07TS** With cable and click-in connector

TECHNICAL SPECIFICATIONS

- Functions:** Front Marker
- Operating Voltage:** 24V DC
- Consumption:** 0,5W
- Type of Protection:** IP67

LED FRONT MARKER LAMP



ECE APPROVED

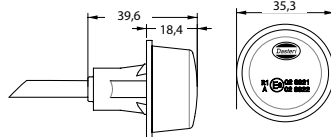

REF. No

- DSL-3081/12** 12 Volt
- DSL-3081/24** 24 Volt

TECHNICAL SPECIFICATIONS

- Functions:** Front Marker
- Operating Voltage:** 12 or 24V DC
- Consumption:**
- Type of Protection:** IP67

LED FRONT MARKER LAMP

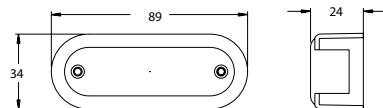

REF. No

- DSL-24.307** Clear lens, White LEDs
- DSL-24.308** Clear lens, Blue LEDs

TECHNICAL SPECIFICATIONS

- Functions:** Front Marker
- Operating Voltage:** 24V DC
- Consumption:** 1W
- Type of Protection:** IP67

LED FRONT MARKER LAMP



ECE APPROVED

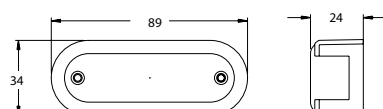

REF. No

- DSL-24.607** Clear lens, white LEDs

TECHNICAL SPECIFICATIONS

- Functions:** Front Marker
- Operating Voltage:** 24V DC
- Consumption:** 1W
- Type of Protection:** IP67

MARKER LAMPS

FRONT MARKER LAMP

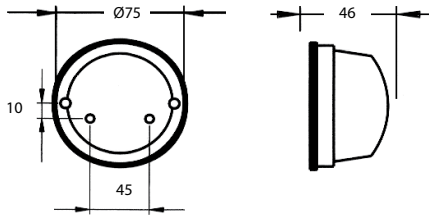

ECE APPROVED

REF. No

8080/26

Front marker lamp

P-8080-26

Spare lens

TECHNICAL SPECIFICATIONS

Functions: Front Marker

Operating Voltage: 12 or 24V DC

Consumption: 1x5W

FRONT MARKER LAMP

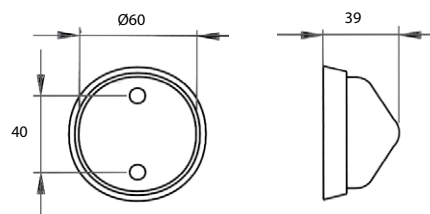

REF. No

8080/29.07

Front marker lamp

P-8080-29.07

Spare lens

TECHNICAL SPECIFICATIONS

Functions: Front Marker

Operating Voltage: 12 or 24V DC

Consumption: 1x5W

FRONT MARKER LAMP

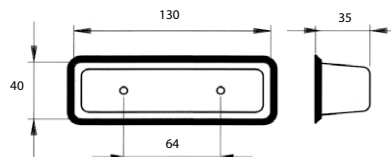

REF. No

8080/31.07

Front marker lamp

P-8080-31.07

Spare lens

TECHNICAL SPECIFICATIONS

Functions: Front Marker

Operating Voltage: 12 or 24V DC

Consumption: 1x5W

FRONT MARKER & D.I. LAMP

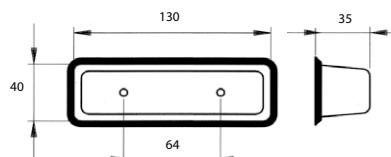

ECE APPROVED

REF. No

8080/30.075

Front marker lamp

P-8080-30.075

Spare lens

TECHNICAL SPECIFICATIONS

Functions: Front Marker,
Direction Indicator

Operating Voltage: 12 or 24V DC

Consumption: 1x5W / 1x18W

FRONT MARKER LAMP

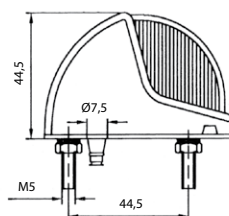

ECE APPROVED

REF. No

618.07

TECHNICAL SPECIFICATIONS

Functions: Front Marker

Operating Voltage: 12 or 24V DC

Consumption: 1x5W

MARKER LAMPS

FRONT MARKER LAMP

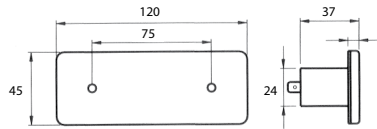

REF. No
530-0.07

TECHNICAL SPECIFICATIONS

Functions: Reflex Reflector
Operating Voltage: 12 or 24V DC
Consumption: 1x3W

FRONT MARKER LAMP

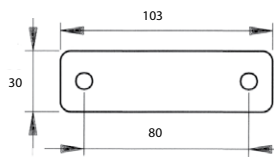

REF. No
8080/34.07

TECHNICAL SPECIFICATIONS

Functions: Front Marker
Operating Voltage: 12 or 24V DC
Consumption: 1x5W

FRONT MARKER LAMP

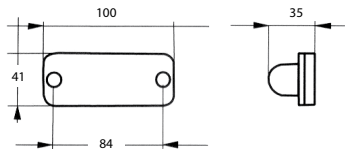

REF. No
8060/39.07

TECHNICAL SPECIFICATIONS

Functions: Front Marker
Operating Voltage: 12 or 24V DC
Consumption: 1x5W

FRONT MARKER LAMP

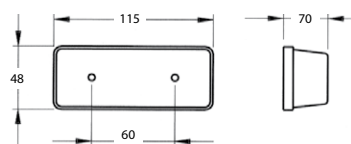

REF. No
8060/43.07 Front marker lamp
P-8060-43.07 Spare lens

TECHNICAL SPECIFICATIONS

Functions: Front Marker
Operating Voltage: 12 or 24V DC
Consumption: 1x5W

LED REAR MARKER LAMP

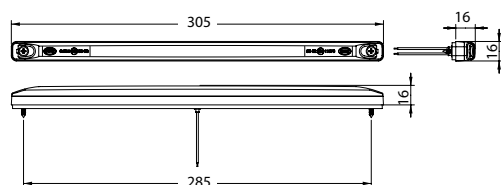

REF. No
DSL-12RT12 12 Volt, clear lens
DSL-12RT24 24 Volt, clear lens

TECHNICAL SPECIFICATIONS

Operating Voltage: 12 or 24V DC
Consumption: (12/24V) 0,6W/0,6W
Type of Protection: IP67

ECE APPROVED EMC APPROVED

LED REAR MARKER LAMP

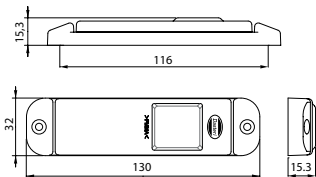

ECE APPROVED

EMC APPROVED

REF. No

550-0.06

With 1m cable

550-0.06TS

With click-in system and 0,5m cable

550-0.06TS15

With click-in system and 1,5m cable

TECHNICAL SPECIFICATIONS

Functions: Rear Marker, Reflex Reflector

Operating Voltage: 9 -33V DC

Consumption: 0,5W

Type of Protection: IP67

LED REAR MARKER LAMP / 560 SERIES

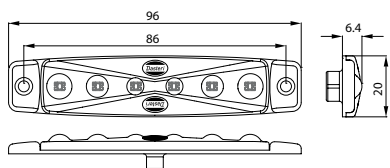

ECE APPROVED

EMC APPROVED

REF. No

560-0.06/12

12 Volt

560-0.06/24

24 Volt

TECHNICAL SPECIFICATIONS

Functions: Rear Marker

Operating Voltage: 12 or 24V DC

Consumption: 0,5W

Type of Protection: IP67

LED REAR MARKER LAMP / 560L LONG VERSION

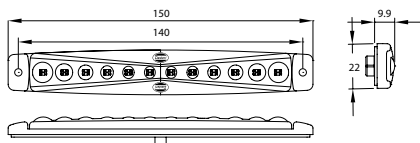

ECE APPROVED

EMC APPROVED

REF. No

560L-0.06/12

12V For Surface Mounting

560L-0.06/24

24V For Surface Mounting

TECHNICAL SPECIFICATIONS

Functions: Rear Marker

Operating Voltage: 12 or 24V

Consumption: 12V: 1.5W 24V:0.9W

Type of Protection: IP67

MARKER LAMPS

LED REAR MARKER LAMP

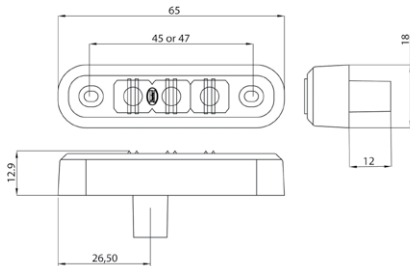

ECE APPROVED

EMC APPROVED

REF. No

DSL-600.06

Red Color lens

DSL-600.07

Clear Color lens

TECHNICAL SPECIFICATIONS

Functions: Rear Position
Operating Voltage: 10-30V DC
Consumption: 1W
Type of Protection: IP67
Cable/Connector: 1000 mm cable

LED REAR MARKER LAMP

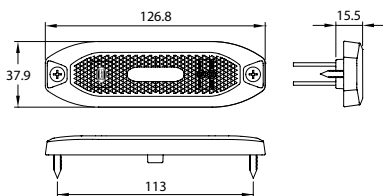

ECE APPROVED

EMC APPROVED

SAE DOT APPROVED

REF. No

DSL-590.06

With Reflex Reflector

TECHNICAL SPECIFICATIONS

Functions: Rear Marker, Reflex Reflector
Operating Voltage: 10-30V
Consumption: 1.5W
Type of Protection: IP67

LED REAR MARKER LAMP

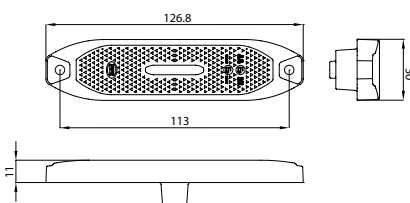

ECE APPROVED

EMC APPROVED

REF. No

DSL-595-0.06

With Reflex Reflector

TECHNICAL SPECIFICATIONS

Functions: Rear Marker, Reflex Reflector
Operating Voltage: 10-30V
Consumption: 1.5W
Type of Protection: IP67

MARKER LAMPS

LED REAR POSITION MARKER LAMP

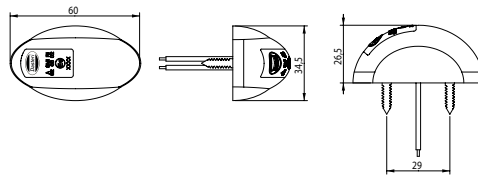

REF. No

DSL-580.06

Red lens

TECHNICAL SPECIFICATIONS

Functions: Rear Marker
Operating Voltage: 10-30V DC
Consumption: (12V/24V) 0,7W/1,4W
Type of Protection: IP67

ECE APPROVED

EMC APPROVED

LED REAR MARKER LAMP

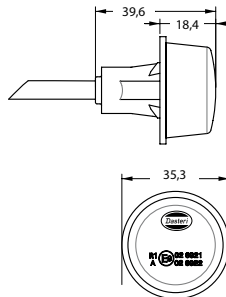

REF. No

DSL-3082/12

Rear 12 Volt

DSL-3082/24

Rear 24 Volt

TECHNICAL SPECIFICATIONS

Functions: Rear Marker
Operating Voltage: 12 or 24V DC
Consumption: 0,5W

ECE APPROVED

LED REAR MARKER LAMP

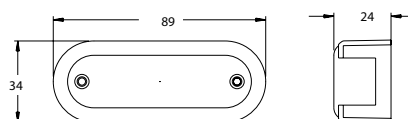

REF. No

DSL-24.306

TECHNICAL SPECIFICATIONS

Functions: Rear Marker
Operating Voltage: 24V DC
Consumption: 1W
Type of Protection: IP67

ECE APPROVED

LED REAR MARKER LAMP 24V

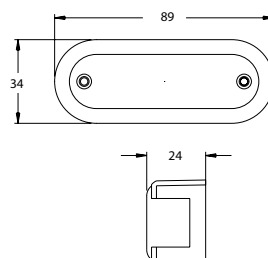

REF. No

DSL-24.606

TECHNICAL SPECIFICATIONS

Functions: Rear Marker
Operating Voltage: 24V DC
Consumption: 0,5W
Type of Protection: IP67

ECE APPROVED

LED REAR MARKER LAMP

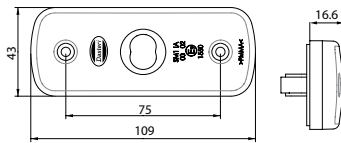

REF. No
543-0.06C/12 12 Volt
543-0.06C/24 24 Volt

TECHNICAL SPECIFICATIONS

Functions: Rear Marker, Reflex Reflector
Operating Voltage: 12 or 24V DC
Consumption: 0,5W
Type of Protection: IP67

ECE APPROVED

LED REAR MARKER LAMP

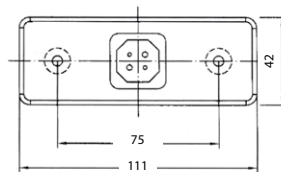

REF. No
542-0.06/24 24 Volt with 25cm cable
542E0-0.06 Economy Line, 10-30V, cable
542E1-0.06 Economy Line, 10-30V, With 2-pole Connector

TECHNICAL SPECIFICATIONS

Functions: Rear Marker, Reflex Reflector
Operating Voltage: 24V DC
Consumption: 0,5W
Type of Protection: IP67

ECE APPROVED

REAR MARKER LAMP

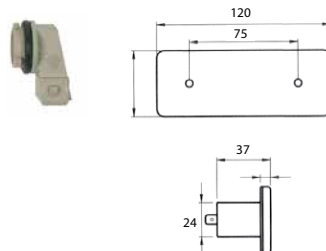

REF. No
530-0.06

TECHNICAL SPECIFICATIONS

Functions: Rear Marker, Reflex Reflector
Operating Voltage: 24V DC
Consumption: 0,5W
Type of Protection: IP67

ECE APPROVED

REAR MARKER LAMP

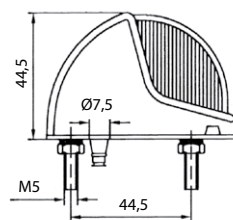

REF. No
618.06

TECHNICAL SPECIFICATIONS

Functions: Rear Marker
Operating Voltage: 12 or 24V DC
Consumption: 1X5W

ECE APPROVED

REAR MARKER LAMP

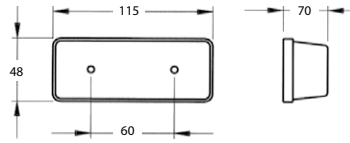

REF. No
8060/43.06 Rear marker lamp
P-8060-43.06 Spare lens, Red

TECHNICAL SPECIFICATIONS

Functions: Rear Marker
Operating Voltage: 12 or 24V DC
Consumption: 1x5W

REAR MARKER LAMP

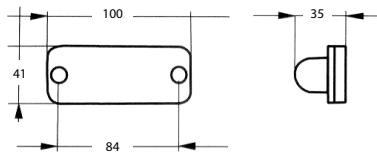

REF. No
8060/39.06 12 Volt

TECHNICAL SPECIFICATIONS

Functions: Rear Marker
Operating Voltage: 12 or 24V DC
Consumption: 1x5W

REAR MARKER & D.I. LAMP

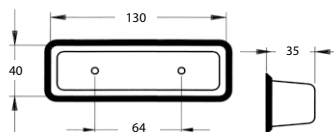

REF. No
8080-30.065 Rear marker lamp
P-8080-30.065 Spare lens

TECHNICAL SPECIFICATIONS

Functions: Rear Marker, Direction Indicator
Operating Voltage: 12 or 24V DC
Consumption: 1x5W, 1x18W

REAR MARKER LAMP

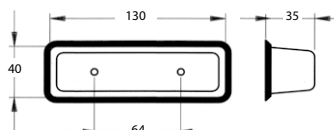

REF. No
8080/31.06 Spare lens, red

TECHNICAL SPECIFICATIONS

Functions: Rear Marker
Operating Voltage: 12 or 24V DC
Consumption: 1x5W

REAR MARKER LAMP

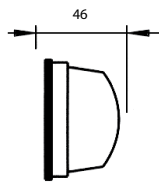
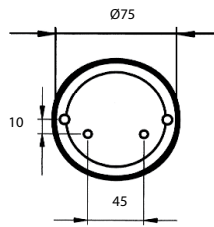

REF. No

8080/25

Red lens

P-8080-25

Spare lens, red

TECHNICAL SPECIFICATIONS

Functions: Rear Marker, Reflex Reflector

Operating Voltage: 12 or 24V DC

Consumption: 1x5W

ECE APPROVED

REAR MARKER LAMP

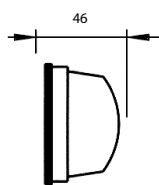
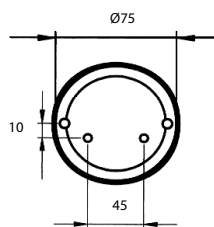

REF. No

133.06

Red lens

P-133.06

Spare lens, red

TECHNICAL SPECIFICATIONS

Functions: Rear Marker

Operating Voltage: 12 or 24V DC

Consumption: 1x5W

REAR MARKER LAMP

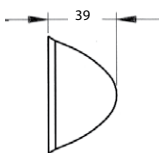
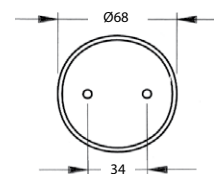

REF. No

8080/51A.06

Red lens

P-8080-51A.06

Spare lens, red

TECHNICAL SPECIFICATIONS

Functions: Rear Marker

Operating Voltage: 12 or 24V DC

Consumption: 1x5W

REAR MARKER & D.I. LAMP

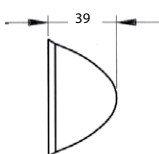
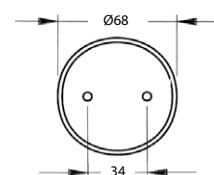

REF. No

8080/51.06

Red lens

P-8080-51.06

Spare lens, red

TECHNICAL SPECIFICATIONS

Functions: Rear Marker, Direction Indicator

Operating Voltage: 12 or 24V DC

Consumption: 1x5W

REAR MARKER LAMP

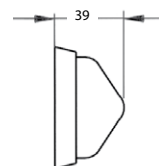
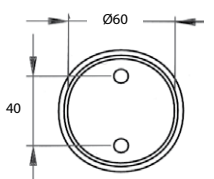

REF. No

8080/29.06

Red lens

P-8080-29.06

Spare lens, red

TECHNICAL SPECIFICATIONS

Functions: Rear Marker

Operating Voltage: 12 or 24V DC

Consumption: 1x5W



INTERIOR LAMPS





LED INTERIOR LAMP SERIES DSL-PL10

TECHNICAL SPECIFICATIONS

Operating Voltage: 10-30V DC
Operating Temperature: -40 °C to +65 °C
Consumption: 3W
Type of Protection: IP67

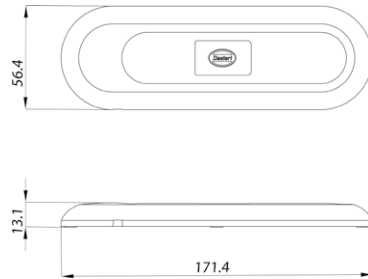
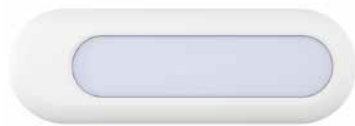

WITH WIRE EXIT

REF. No **DSL-PL10C**

EMC APPROVED

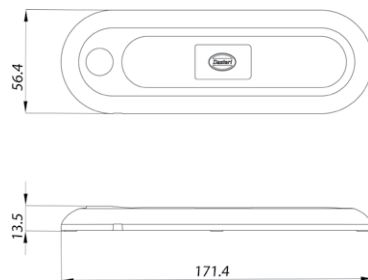

WITH TOUCH BUTTON

REF. No **DSL-PL10B**

EMC APPROVED

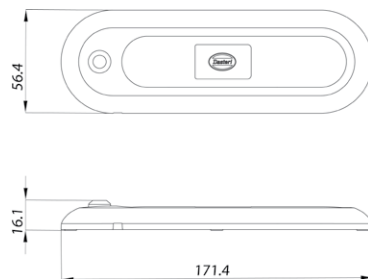

WITH MOTION SENSOR

REF. No **DSL-PL10MS**

EMC APPROVED

LED INTERIOR LAMP SERIES DSL-PL20

TECHNICAL SPECIFICATIONS

Operating Voltage: 10-30V DC
Operating Temperature: -40 °C to +65 °C
Consumption: 3W
Type of Protection: IP67

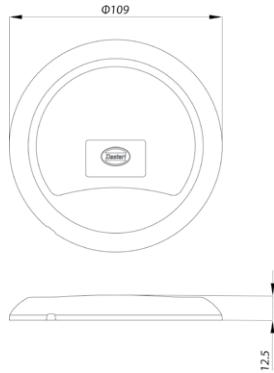

WITH WIRE EXIT

REF. No **DSL-PL20C**

EMC APPROVED

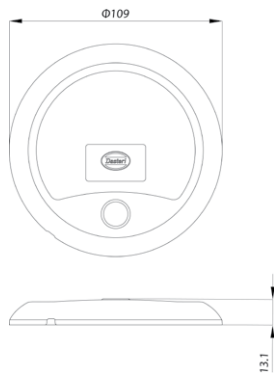

WITH TOUCH BUTTON

REF. No **DSL-PL20B**

EMC APPROVED

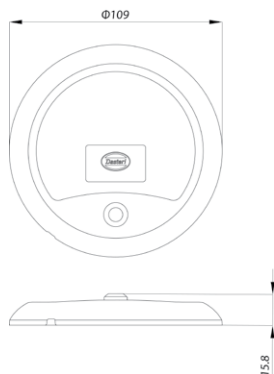

WITH MOTION SENSOR

REF. No **DSL-PL20MS**

EMC APPROVED

LED INTERIOR LAMP / DSBTA SERIES

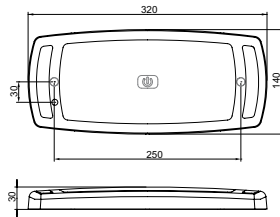

REF. No

DSBTAW.ND.G

LED Interior Lamp without Button

DSBTAW.ND.GB

LED Interior Lamp with Button

TECHNICAL SPECIFICATIONS

Operating Voltage: 10-30V DC
Consumption: 5W-6W
Type of Protection: IP67

LED INTERIOR LAMP DSPN SERIES

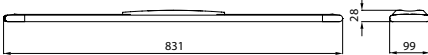
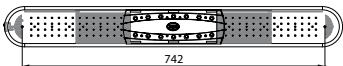
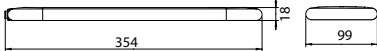
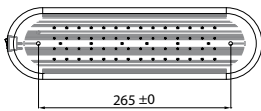

REF. No

DSPN1228WNB

28 clear LEDs, 3 blue night LEDs (with switch) 234mm, 12V

DSPN2428WNB

28 clear LEDs, 3 blue night LEDs (with switch) 234mm, 24V

DSPN60WNB

60 clear LEDs, 6 blue night LEDs (with switch) 353mm, 10-30V

DSPN84WNB

84 clear LEDs, 9 blue night LEDs (with switch) 472mm, 10-30V

DSPN144WNB

140 clear LEDs, 15 blue night LEDs (with switch) 710mm, 10-30V

DSPN120WNB

112 clear LEDs, 12 blue night LEDs (with switch) 831mm, 10-30V (with design blue LED trim option)

TECHNICAL SPECIFICATIONS

Operating Voltage: 12 or 24V DC
Consumption: From 2,5W to 12,5W

LED INTERIOR LAMP DSPE SERIES

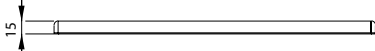
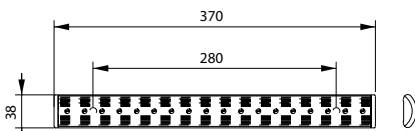

REF. No

DSPE-1230

with 30 LEDs, 12V, 610mm

DSPE-2430

with 30 LEDs, 24V, 610mm

DSPE-1218

with 18 LEDs, 12V, 370mm

DSPE-2418

with 18 LEDs, 24V, 370mm

DSPE-1206

with 6 LEDs, 12V, 130mm

DSPE-2406

with 6 LEDs, 24V, 130mm

add .08

for blue lens

TECHNICAL SPECIFICATIONS

Operating Voltage: 12 or 24V DC
Consumption: From 0,5W to 1,5W

* Drawing is for 370mm version

LED SPOT DSSPD SERIES

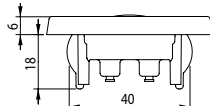
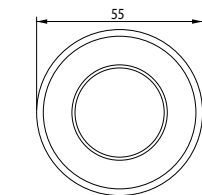

REF. No

DSSPD12W6.W

12 Volt, White base

DSSPD24W6.W

24 Volt, White base

DSSPD12W6.G

12 Volt, Grey base

DSSPD24W6.G

24 Volt, Grey base

TECHNICAL SPECIFICATIONS

Operating Voltage: 12 or 24V DC
Consumption: (12/24V) 1,2W / 1,2W
Operating Temperature: -30 °C to +85 °C
Type of Protection: IP67

LED INTERIOR LAMP DSTA SERIES

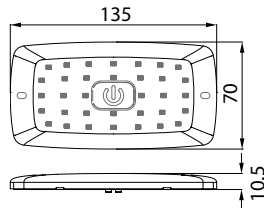

REF. No

- DSTA12W34B** 34 white LEDs, OUTSIDE LOOK: Clear lens with touch button
- DSTA24W34B** 34 white LEDs, OUTSIDE LOOK: Clear lens with touch button
- DSTA12W30** 30 white LEDs, OUTSIDE LOOK: Clear lens
- DSTA24W30** 30 white LEDs, OUTSIDE LOOK: Clear lens

TECHNICAL SPECIFICATIONS

- Operating Voltage:** 12 or 24V DC
- Consumption:** (12V/24V) 2W/3W

LED INTERIOR LAMP DSTC SERIES

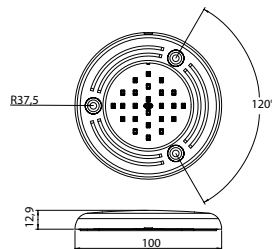

REF. No

- DSTC12W24** 24 white LEDs, 12V
- DSTC24W24** 24 white LEDs, 24V
- DSTC12R24** 24 red LEDs, 12V
- DSTC24R24** 24 red LEDs, 24V
- DSTC12B24** 24 blue LEDs, 12V
- DSTC24B24** 24 blue LEDs, 24V
- DSTC12Y24** 24 amber LEDs, 12V
- DSTC24Y24** 24 amber LEDs, 24V

TECHNICAL SPECIFICATIONS

- Operating Voltage:** 12 or 24V DC
- Consumption:** (12V/24V) 1,5W/2W

NEW

LED INTERIOR LAMP DSSPE SERIES

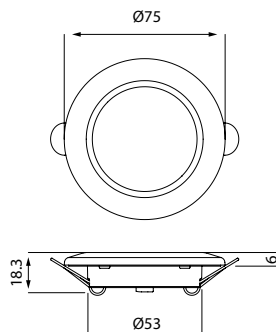

REF. No

- DSSPE-12.07** White LEDs, 12V
- DSSPE-24.05** Amber LEDs, 24V
- DSSPE-24.06** Red LEDs, 24V

TECHNICAL SPECIFICATIONS

- Operating Voltage:** 12V DC (White) / 22-32V DC (Amber, Red)
- Consumption:** 6x0.5W
- Operating Temperature:** -40 °C to +85 °C
- Type of Protection:** IP54

LED INTERIOR LAMP

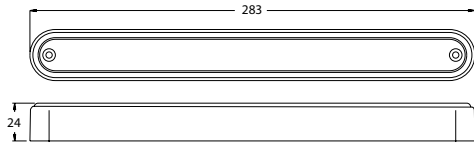

EMC APPROVED

REF. No

DSL-24.1207 24 Volt

DSL-12.1207 12 Volt

TECHNICAL SPECIFICATIONS

Operating Voltage: 12 or 24V DC

Consumption: (12/24V) 0,6W / 1W

LED INTERIOR FLEXIBLE LAMP

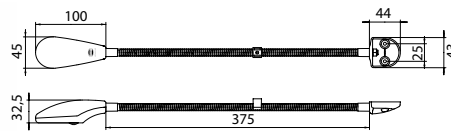

REF. No

DSL-GN01

TECHNICAL SPECIFICATIONS

Operating Voltage: 10-30V DC

Consumption: 1.6W

LED ZONE LIGHT DSL-Z SERIES

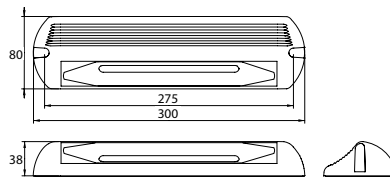

REF. No

DSL-Z36 1000lm

TECHNICAL SPECIFICATIONS

Operating Voltage: 10-30V DC

Consumption: 11W

Type of Protection: IP67

LED ZONE LIGHT DSL-Z SERIES

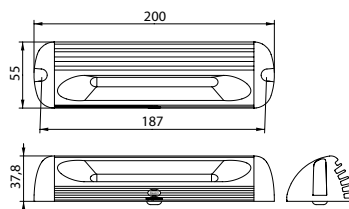

REF. No

DSL-Z24 750lm

TECHNICAL SPECIFICATIONS

Operating Voltage: 10-30V DC

Consumption: 10W

Type of Protection: IP67

LED ZONE LIGHT DSL-Z SERIES

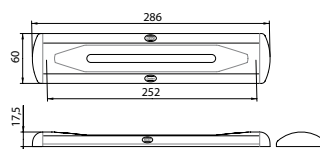

REF. No

DSL-Z18 500lm

TECHNICAL SPECIFICATIONS

Operating Voltage: 10-30V DC

Consumption: 9W

Type of Protection: IP67

LED ZONE LIGHT DSL-Z SERIES

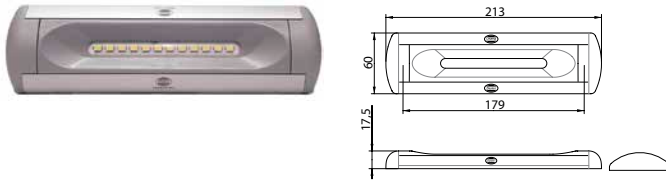

REF. No
DSL-Z12/12 500lm, 12 Volt
DSL-Z12/24 500lm, 24 Volt

TECHNICAL SPECIFICATIONS
Operating Voltage: 12 or 24V DC
Consumption: 2,5W
Type of Protection: IP67

LED ZONE LAMP / DSL-Z12N



REF. No
DSL-Z12N/12 12V
DSL-Z12N/24 24V

TECHNICAL SPECIFICATIONS
Operating Voltage: 12 or 24V DC
Consumption: 6W
Type of Protection: IP67

LED INTERIOR LAMP

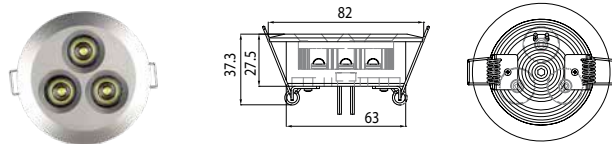

REF. No
DSSP3W65 With 3 LEDs

TECHNICAL SPECIFICATIONS
Operating Voltage: 9-33V DC
Consumption: 3,5W

LED INTERIOR LAMP

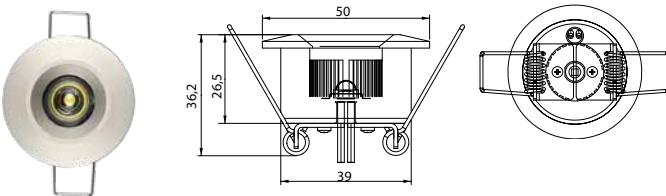

REF. No
DSSP1W40 With 1 LED

TECHNICAL SPECIFICATIONS
Operating Voltage: 9-33V DC
Consumption: 1,5W

LED PROFILE CORRIDOR LAMP DSPK SERIES

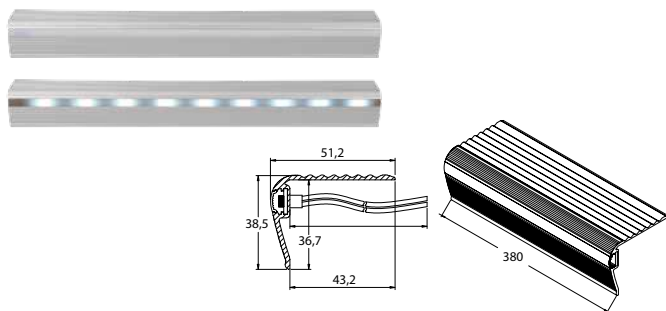

REF. No
DSPK24W380WP White colour LEDs
DSPK24Y380WP Amber colour LEDs
DSPK24R380WP Red colour LEDs
DSPK24B380WP Blue colour LEDs

TECHNICAL SPECIFICATIONS
Operating Voltage: 24V DC
Consumption: From 1,5W to 2,6W

LED INTERIOR LAMP DSSPC SERIES

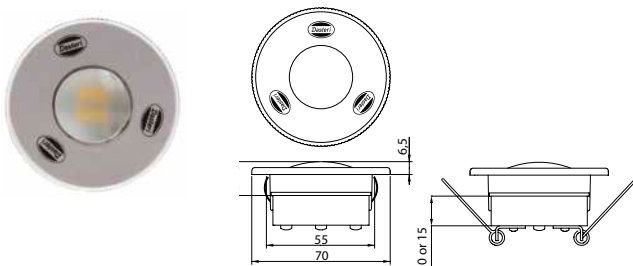

REF. NO.
DSSPCWW10C Interior LED lamp 1000 lm 10-30V
DSSPC12WW6C Interior LED lamp 500 lm 12V
DSSPC24WW6C Interior LED lamp 500 lm 24V

TECHNICAL SPECIFICATIONS
Operating Voltage: 12 or 24V DC

INTERIOR LAMP

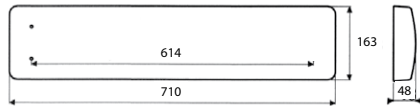

REF. No

PL-060/12V 12 Volt with built-in electronically operated converter

PL-060/24V 24 Volt with built-in electronically operated converter

TECHNICAL SPECIFICATIONS

Operating Voltage: 12 or 24V DC

Consumption: 18W

INTERIOR LAMP

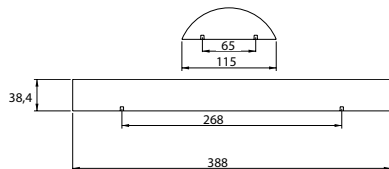

REF. No

DSTL-710 Dual Voltage

TECHNICAL SPECIFICATIONS

Operating Voltage: 12 or 24V DC

Consumption: 8W

INTERIOR LAMP

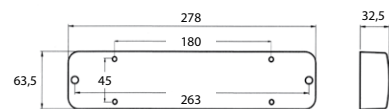

REF. No

PL-040/12V 12 Volt with built-in electronically operated converter

PL-040/24V 24 Volt with built-in electronically operated converter

TECHNICAL SPECIFICATIONS

Operating Voltage: 12 or 24V DC

Consumption: 6W

INTERIOR LAMP

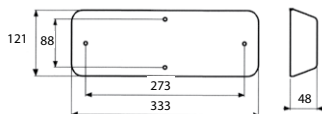

REF. No

PL-050 White Lens

TECHNICAL SPECIFICATIONS

Operating Voltage: 12 or 24V DC

Consumption: 1x3W

INTERIOR LAMP

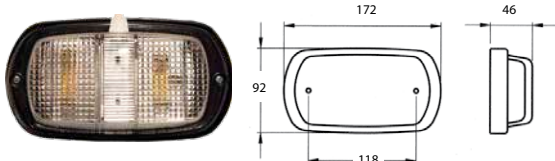

REF. No

PL-045 With clear lens & plastic trim

PL-045N With clear lens & chrome-type trim

TECHNICAL SPECIFICATIONS

Operating Voltage: 12 or 24V DC

Consumption: 2x5W

INTERIOR LAMP

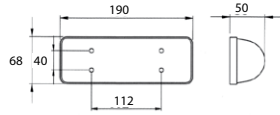

REF. No
PL-048 With clear lens

TECHNICAL SPECIFICATIONS

Operating Voltage: 12 or 24V DC
Consumption: 2x5W or 2x10W

INTERIOR LAMP

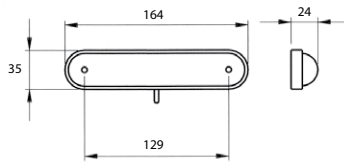

REF. No
PL-101 With clear lens & switch
PL-102 With clear lens

TECHNICAL SPECIFICATIONS

Operating Voltage: 12 or 24V DC
Consumption: 2x5W

INTERIOR LAMP

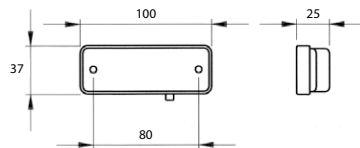

REF. No
PL-103 With clear lens & switch
PL-103.012 With white lens & switch

TECHNICAL SPECIFICATIONS

Operating Voltage: 12 or 24V DC
Consumption: 1x5W

INTERIOR LAMP

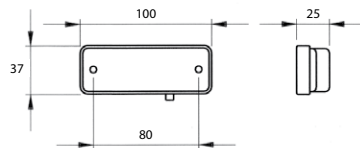

REF. No
PL-104.012 With white lens & switch

TECHNICAL SPECIFICATIONS

Operating Voltage: 12 or 24V DC
Consumption: 1x5W

INTERIOR LAMP

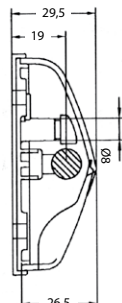

REF. No
PL-619.012

TECHNICAL SPECIFICATIONS

Operating Voltage: 12 or 24V DC
Consumption: 1x5W



REFLEX REFLECTORS

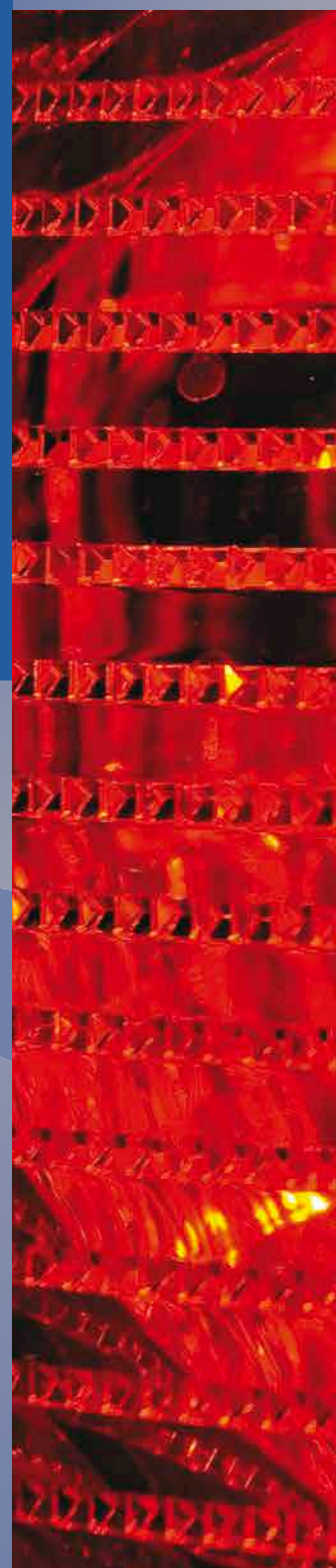

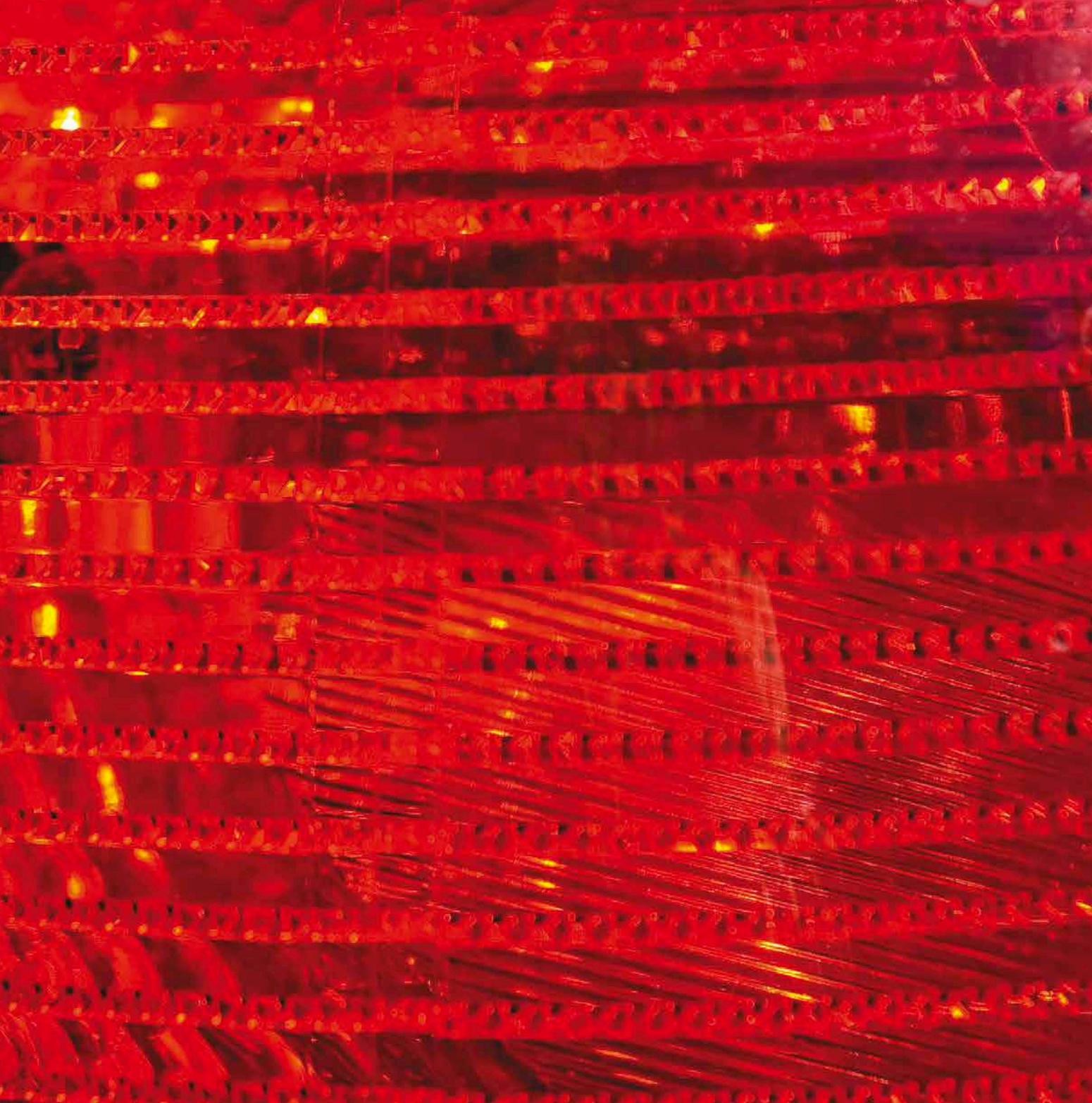

RING REFLEX REFLECTOR

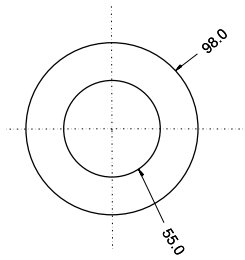

REF. No
DSL0400RR.06 Ring reflex reflector

ECE APPROVED

TRIANGLE REFLEX REFLECTOR

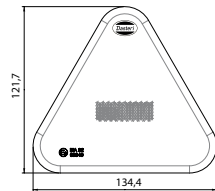

REF. No
D-002 Ring reflex reflector

ECE APPROVED

TRIANGLE REFLEX REFLECTOR

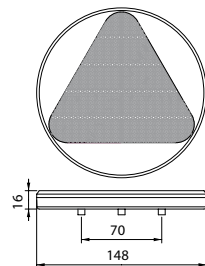

REF. No
D-002B Red reflecting surface

ECE APPROVED

TRIANGLE REFLEX REFLECTOR

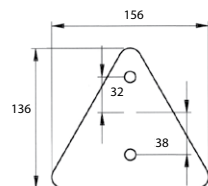

REF. No
D-001 Red, reflecting surface, 85 sq. cm

ECE APPROVED

RECTANGULAR REFLEX - REFLECTOR

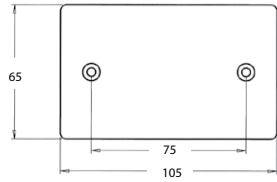

REF. No

P-010.05

P-010.06

P-010.07

Amber

Red

Clear

ROUND REFLEX - REFLECTOR Ø60mm

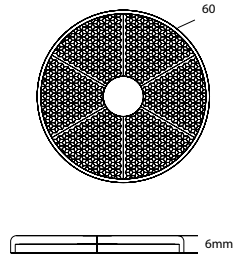

REF. No

P-040.05

P-040.06

P-040.07

Amber

Red

Clear

ECE APPROVED

ROUND REFLEX - REFLECTOR Ø80mm

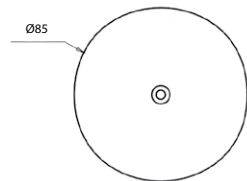

REF. No

P-030.05

P-030.06

P-030.07

Amber

Red

Clear

RECTANGULAR REFLEX - REFLECTOR

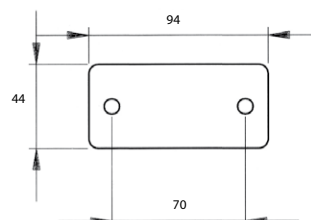
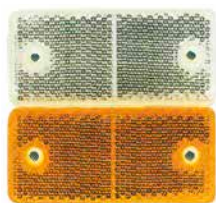

REF. No

P-005.05

P-005.06

P-005.07

Amber

Red

Clear



WIRING KITS & VARIOUS PARTS





PUSH - BUTTON SWITCH, MOMENTARY



REF. No
B-218 With screws in terminals

SWITCH ON - OFF FOR BRAKING LIGHTS



REF. No
704 Stop - STAYER

FOR MILITARY VEHICLES



REF. No
814-1-SYS All metal housing, electrostatic paint

FOR MILITARY VEHICLES



REF. No
815-1-SYS Plastic housing

FUSE BOX



REF. No
AS-011 6 - pole

6 - OR 12 POLE CABLE CONNECTOR SET



REF. No
K-911-6 With 6 screw contacts, black
K-911-12 With 12 screw contacts, black
K-911-6W With 6 screw contacts, white
K-911-12W With 12 screw contacts, white

INTERIOR BUZZER

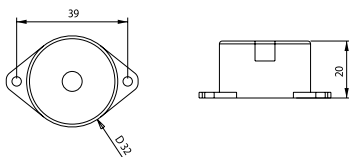

REF. No
DSBH888 Dual voltage (12V / 24V) 70db, tone - pulse

BACK HORN (BUZZER)



REF. No
DSBH834 Back horn dual voltage (12V / 24V) 88db in 12V and 94db in 24V, tone - pulse

BUS SIGN UNIT



REF. No
DSSI750 Bus stop light

MIRROR ARM FOR UNIVERSAL APPLICATION



REF. No
BAS-1 Right side
BAS-2 Left side

ELECTRONIC FLUORESCENT INVERTERS



REF. No	VOLT	WATT	W (mm)	L (mm)	H (mm)
655/12/18	12	18	38	167	28
655/24/18	24	18	38	167	28
655/12/36	12	36	38	167	28
655/24/36	24	36	38	167	28

EXTERNAL MIRROR



REF. No
KA8-1 Right - Left, with curvature
Dimensions 260 x 175 mm

2 - POLE SOCKET, 1 FLAT PLUG CONTACT



REF. No
F-125 Ø: 18mm

2 - POLE SOCKET, 2 FLAT PLUG CONTACTS



REF. No
F-126 Ø: 18mm

POLE PLUG



REF. No
F-127 2 pole plug

VENTILATOR FOR BUSES, TRUCKS, CAMPERS

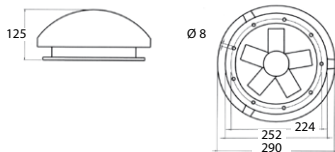

REF. No
300/12V Outside unit, 12V motor, 3500 rpm., 600 - 650 m³ / hour capacity, reverse capability.
300/24V Outside unit, 24V motor, 3500 rpm., 600 - 650 m³ / hour capacity, reverse capability
Colors: Black or white

CLOSING MECHANISM FOR 300/12 & 300/24

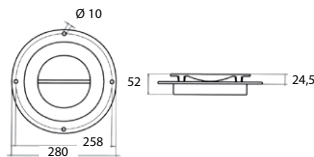

REF. No
300/1 Closing mechanism for ventilators 300/12 & 300/24
Colors: Black or white

MOUNTING BASE SIDE INSTALLATION

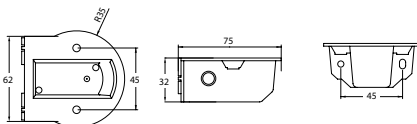

REF. No
MB10 Base for installation of series: DLL, DLS, DXL, DXS

MOUNTING BASE SURFACE INSTALLATION

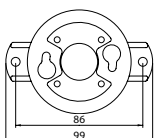

REF. No
MB15 Base for installation of series: DLL, DLS, DXL, DXS

FLEXIBLE MOUNTING BASE FASTENING ON TUBE

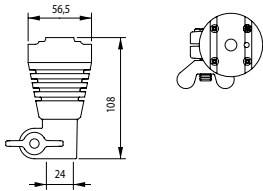

REF. No
MB20

Mounting base

CHROME RING

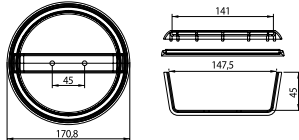

REF. No
SET-18N

With metallic base application:
For LED round lamps and series 3100

CHROME RING

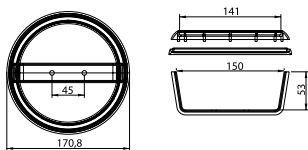

REF. No
SET-17N

With metallic base application:
For lamps with ref. 8080/18 and 8080/17

CHROME RING



REF. No
SET-230N

For lamps with ref. no DSL-230
and all lamps of 122mm diameter

BASE FOR FLUSH FITTING

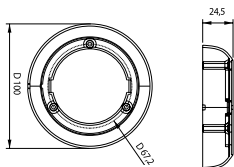

REF. No
BASE-DS-SL

For interior lamps with 18 LEDs

ANGLED BRACKET



REF. No
SET-530
SET-550
SET-560

For side marker lamps of series 530, 540
For side marker lamps of series 550
For side marker lamps of series 560

ANGLED BASE FOR DSL-590 AND DSL-595



REF. No
SET-590-595

Angled base for DSL-590 and DSL-595

ANGLED BASE FOR DSL-640



REF. No
SET-640

Angled Base for DSL-640

SURFACE MOUNTING KIT FOR DSL-45

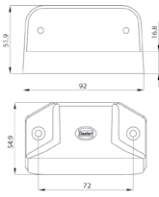

REF. No
SET-45B
Surface Mounting Kit For DSL-45

Includes 2x screws for mounting of the lamp and 2x screws for the mounting of the kit

DUAL CABLE



REF. No
TH-032-02 Dual cable with "click-in system" 500mm

BULB HOLDER



REF. No
BH-0143 For side marker lamps

BULB HOLDER



REF. No
BH-0143C With dual cable and isolation

BULB HOLDER



REF. No
BH-0143CC With hard dual cable and cover

MOUNTING TUBE - RUBBER CAP



REF. No
411.01 For use with beacons 411/12V, 411/24V, 431/12V, 431/24V, 421/12V, 421/24V, 441/DV, 446/DV
Height: 100mm, Ø 24mm

MOUNTING TUBE - THREADED M14 RUBBER CAP



REF. No
411.02 For use with beacons 411/12V, 411/24V, 431/12V, 431/24V, 421/12V, 421/24V, 441/DV, 446/DV, 461, 466/DV
Height: 100mm, Ø 24mm

ADAPTOR FOR BASE OF BEACON SERIES 430

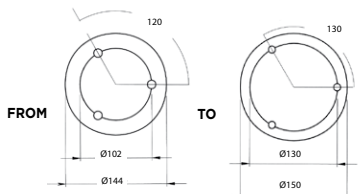

REF. No
SET-EXBA430

MODULE DEVICE FOR SIDEMARKER/D.I.



REF. No
DSL-MDI.S

Module device for Sidemarker and Direction Indicator (dual usage)

Operating Voltage: Multivoltage 10-30V DC
One Device needed per Vehicle

LED LOAD MODULE

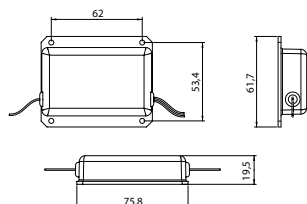

REF. No
DSL-MDL/12 Led load module 12V
DSL-MDL/24 Led load module 24V

JUNCTION BOX WITH FEMALE CONNECTORS



REF. No
K-918F

For trailer wiring systems

FEMALE CONNECTOR

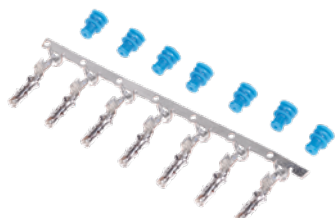

REF. No
SET-F-1,5 For 1,5mm PINS

FEMALE CONNECTOR



REF. No
SET-F-2094

For rear lamps R-2094SR and L-2095SR



MODULE BOX FOR SIDEMARKER / D.I.

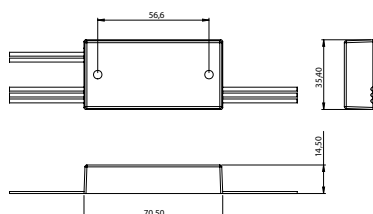

REF. No
DSL-MDI

Module Box for Sidemarker and Direction Indicator (dual usage). Multivoltage 10-30V DC,
One module box needed for both lines

LOAD MODULE FOR REAR LAMPS



REF. No
DSL-MDL.S Plug & Play

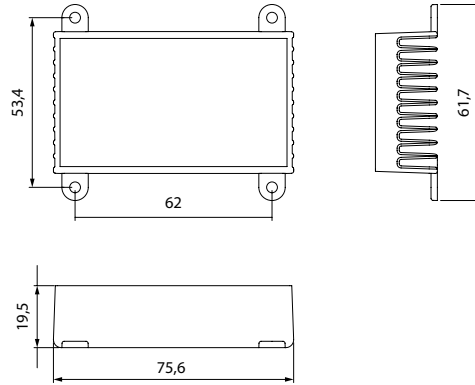

NUMBER PLATE KIT FOR REAR LAMPS



REF. No
SET-601NPL Number Plate included

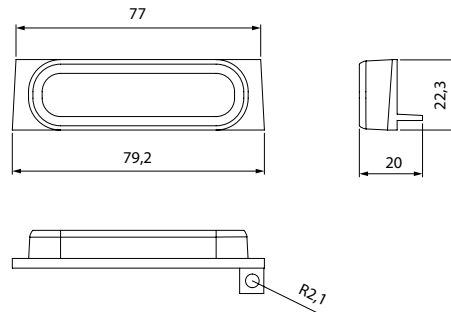

ECE APPROVED

ADAPTOR FOR END-OUTLINE OR SIDEMARKER LAMPS



REF. No
SET-620 Screws are included

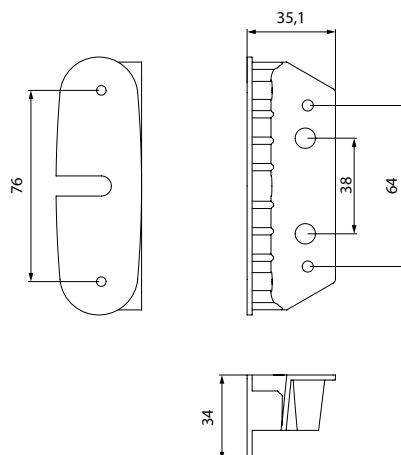

CREATE YOUR OWN WIRING KIT

- Step 1:** Choose **WIRING KIT** version from drawings
- Step 2:** Choose **TAIL LAMP** from **A LIST**
- Step 3:** Choose **SIDE MARKER LAMP** from **B LIST**
- Step 4:** Choose **MARKER LAMP** from **C LIST**
- Step 5:** Choose **END-OUTLINE MARKER LAMP** from **D LIST**
- Step 6:** Choose **NUMBER PLATE LAMP** from **E List**

Examples of final Ref codes:
WKJ - A5B2C1D2E3 or **WK - A5B2C1D2E4**

For **Junction Box** version
 choose **WKJ-**

For **Non-Junction Box** version
 choose **WK-**

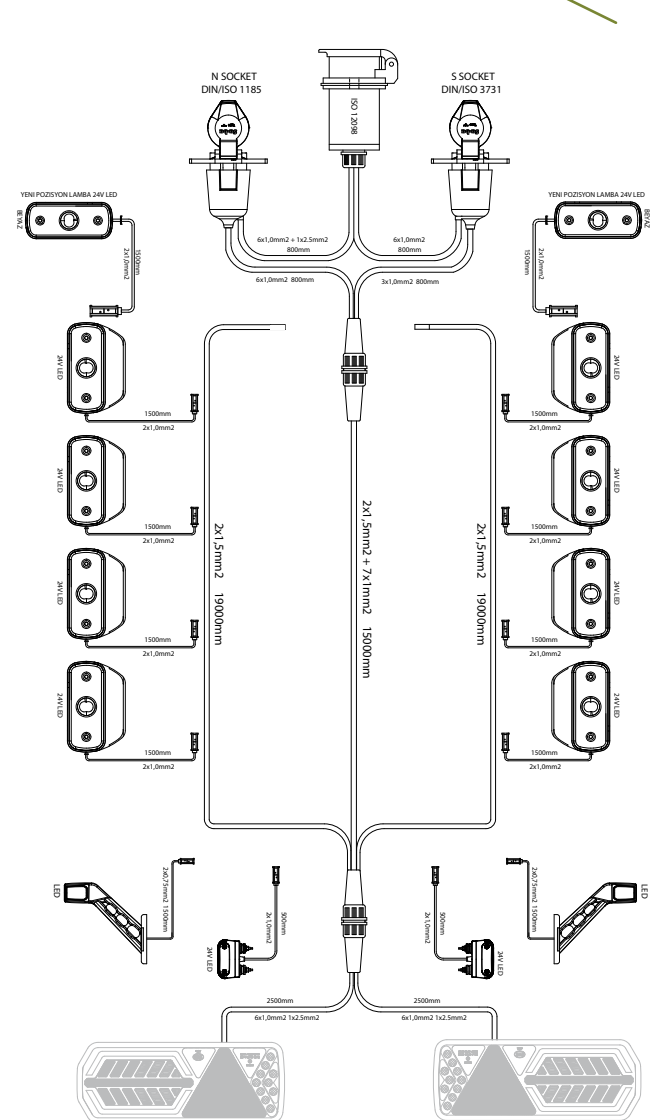
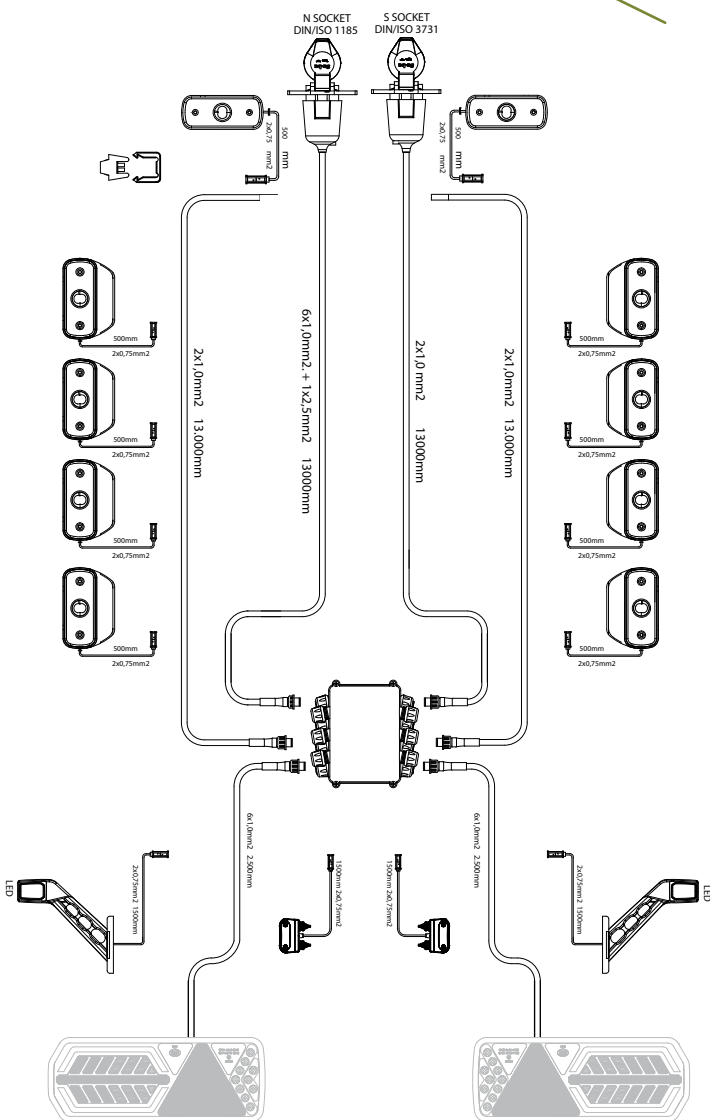

CREATE YOUR OWN WIRING KIT

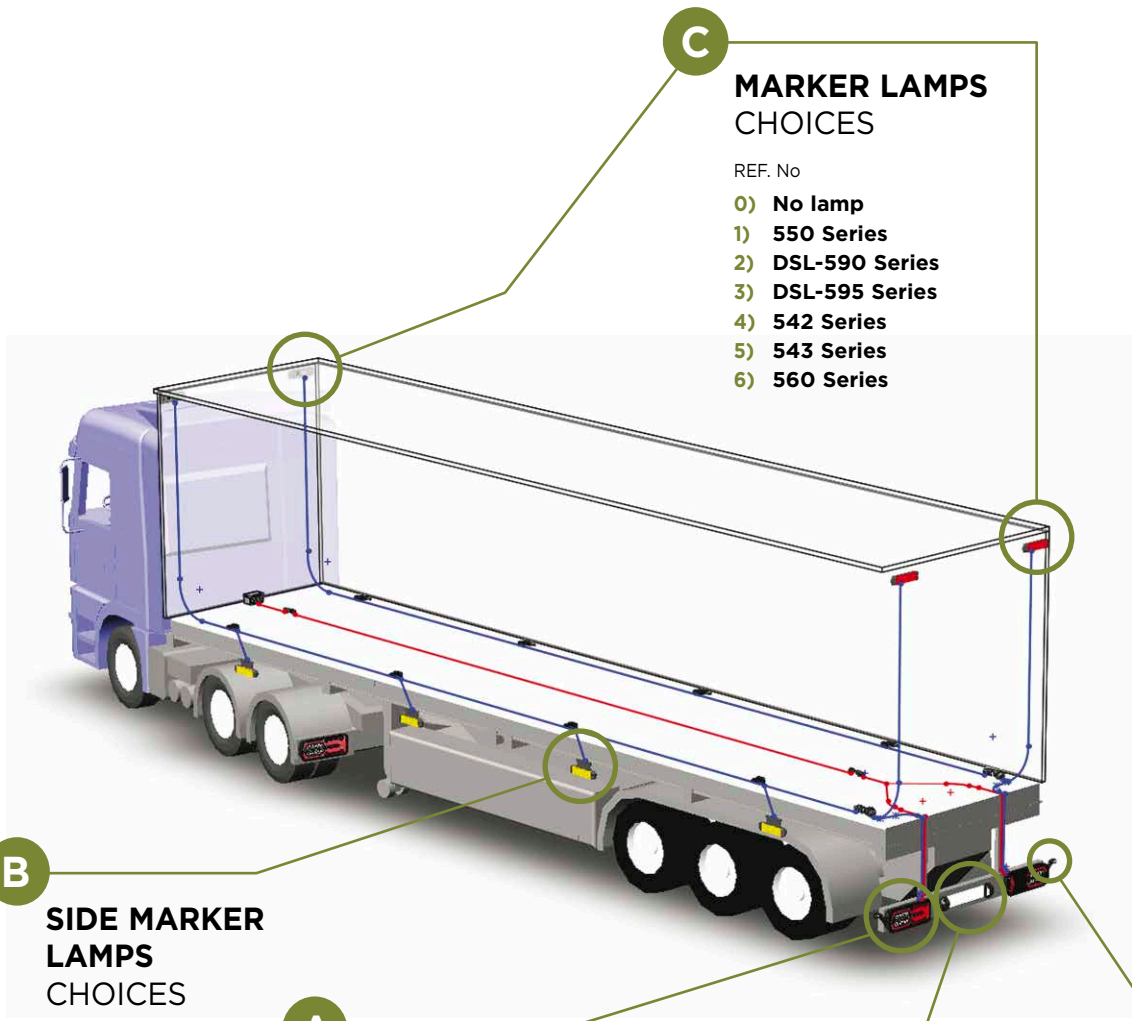

- C**
- MARKER LAMPS CHOICES**
- REF. No
- 0) No lamp
 - 1) 550 Series
 - 2) DSL-590 Series
 - 3) DSL-595 Series
 - 4) 542 Series
 - 5) 543 Series
 - 6) 560 Series

- B**
- SIDE MARKER LAMPS CHOICES**
- REF. No
- 0) No lamp
 - 1) DSL-590 Series
 - 2) DSL-595 Series
 - 3) 542 Series
 - 4) 550 Series
 - 5) 530L Series
 - 6) 543 Series

- A**
- TAIL LAMPS CHOICES**
- REF. No
- 0) No lamp
 - 1) DSL-5000 Series
 - 2) DSL-5100 Series
 - 3) DSL-2030 Series
 - 4) DSL-2040 Series
 - 5) DSL-2050 Series
 - 6) 2110 (Bulb) Series
 - 7) DSL-6000 Series
 - 8) DSL-7000 Series

- E**
- NUMBER PLATE LAMP CHOICES**
- REF. No
- 0) No lamp
 - 1) DSL-41A Series
 - 2) DSL-41B Series
 - 3) DSL-42A Series
 - 4) DSL-43A Series
 - 5) DSL-43B Series

- D**
- END-OUTLINE MARKER LAMPS CHOICES**
- REF. No
- 0) No lamp
 - 1) DSL-620 Series
 - 2) DSL-610 Series
 - 3) DSL-622 Series
 - 4) DSL-630 Series
 - 5) DSL-611 Series
 - 6) DSL-613 Series

* The above mentioned Dasteri lamps are indicative. Any combination of Tail, Side Marker, Front Position, End-Outline marker lamps is available upon request. ** For custom wire dimensions please contact us.



Lighting your needs

**NIK, DASTERIDIS S.A., (MFG)
DASTERI SYSTEMS S.A.**

**1st km of Alexandroupoli-Ferres road
Alexandroupoli, 68 133 Greece**

**Tel: +30 25510 25171, 33467
Fax: +30 25510 21689
Email: info@dasteri.gr**

WWW.DASTERI.GR